



Operator Manual

OSD2284P

**Lite Managed 6-port Ethernet Switch with
4 x 10/100/1000BASE-T with 802.3bt PoE &
2 x Gigabit SFP**

INDEX 1

1	TECHNICAL SUMMARY	5
1.1	BRIEF DESCRIPTION	5
1.1.1	OVERVIEW	5
1.1.2	FEATURES AND BENEFITS	5
1.2	TYPICAL SYSTEM DESIGN	6
1.3	TECHNICAL SPECIFICATIONS	7
1.4	PORT ALLOCATION	8
2	INSTALLATION AND OPERATION	9
2.1	INTRODUCTION	9
2.2	INSTALLATION	9
2.2.1	WARNING AND PRECAUTIONS	9
2.2.2	DRAWINGS AND DIMENSIONS	10
2.2.3	LOCATION	11
2.2.4	POWER SUPPLY CONNECTIONS	11
2.2.5	ALARM CONNECTION	12
2.2.6	USB CONNECTOR	13
2.2.7	MINI USB PORT	14
2.2.8	LED INDICATORS	15
2.2.9	CONTROLS	16
2.2.10	FITTING SFP CONNECTORS	18
2.3	OPERATION	19
2.3.1	CONNECTIONS	19
2.4	COMMAND LINE INTERFACE	21
2.4.1	TERMINAL EMULATION SETUP	21
2.4.2	COMMAND LINE FUNCTIONS	22
3	WEB GUI	41
3.1.1	LOGGING ON TO THE SWITCH	42
3.1.2	GUI MENU	43
4	MAINTENANCE	68
4.1	INTRODUCTION	68
4.2	EXTERNAL INSPECTION	68
4.3	ROUTINE MAINTENANCE	68
5	WARRANTY	69
5.1	WARRANTY PERIOD	69
5.2	REPAIRS	69
5.2.1	WARRANTY REPAIRS	69
5.2.2	OUT-OF-WARRANTY REPAIRS	69
5.2.3	SITE REPAIRS	69
5.2.4	EXCLUSIONS	69
	FIGURE 1: TYPICAL SYSTEM DESIGN	6
	FIGURE 2: PORT ALLOCATION	8
	FIGURE 3: MOUNTING DIMENSIONS	10
	FIGURE 4: POWER SUPPLY CONNECTIONS	11
	FIGURE 5: ALARM OUTPUTS	12
	FIGURE 6: CONTACT CLOSURE OUTPUT	12
	FIGURE 7: USB TYPE B CLI PORT	13
	FIGURE 8: CLI INSTALLATION	13
	FIGURE 9: USB CONNECTOR	14
	FIGURE 10: PORT/LED	15
	FIGURE 11: CONTROLS	16
	FIGURE 12: 8-WAY DIP SWITCH	16
	FIGURE 13: FITTING/REMOVING SFP CONNECTORS	18
	FIGURE 14: REDUNDANT RING CONFIGURATION	19
	FIGURE 15: REDUNDANT RING CONNECTION	20

FIGURE 16: BUS CONNECTION	20
FIGURE 17: SERIAL PORT SETTINGS	21
FIGURE 18: VERSION CHECK	23
FIGURE 19: FACTORY DEFAULT SETTING.....	24
FIGURE 20: IP CONFIGURATION	25
FIGURE 21: TOPOLOGY CHECK	26
FIGURE 22: TOPOLOGY CHECK	27
FIGURE 23: NODE CHECK.....	28
FIGURE 24: LOCAL NODE CHECK.....	29
FIGURE 25: FLOAT BACKUP ENABLED 1.....	30
FIGURE 26: RING TOPOLOGY.....	30
FIGURE 27: FLOAT BACKUP ENABLED 2.....	31
FIGURE 28: FLOAT BACKUP ENABLED 3.....	31
FIGURE 29: FLOAT BACKUP DISABLED 1.....	32
FIGURE 30: FLOAT BACKUP DISABLED 2.....	32
FIGURE 31: FLOAT BACKUP DISABLED 3.....	33
FIGURE 32: NODE IP SET	34
FIGURE 33: NODE ALL CHECK	34
FIGURE 34: REBOOT.....	35
FIGURE 35: SNMP.....	36
FIGURE 36: SNMP MENU.....	37
FIGURE 37: PORT CONTROL	38
FIGURE 38: PORT SECURITY.....	39
TABLE 1: TECHNICAL SPECIFICATIONS.....	7
TABLE 2: POWER CONNECTION	11
TABLE 3: ALARM CONNECTIONS	12
TABLE 4: LED FUNCTION.....	15
TABLE 5: 8-WAY DIP SWITCH SETTINGS	16
TABLE 6: POE MODE SWITCH SETTINGS	17
TABLE 7: TERMINAL COMMAND LINES	22

1 TECHNICAL SUMMARY

1.1 BRIEF DESCRIPTION

1.1.1 OVERVIEW

The OSD2284P is a 6-port lite managed industrial Ethernet switch with four Gigabit RJ45 and two Gigabit SFP uplink ports which can be used as standard ports or as a redundant fiber ring using OSD's proprietary ring protocol. Each RJ45 can provide up to 95W PoE to power a wide range of devices. Along with higher level features including SNMP, VLAN and IGMP snooping the OSD2284P is suitable for use in critical networks. A rugged IP30 casing, fan-less design and wide operating temperature range from -40 to +75°C make it suitable for use in a wide range of harsh industrial environments.

1.1.2 FEATURES AND BENEFITS

- ▲ Complies with IEEE802.3i/802.3u/ 802.3ab 10/100/1000Base-T, IEEE802.3u 100Base-Fx, IEEE802.3z 1000Base-Lx/Sx standards
- ▲ Has a total of six ports: four fixed copper ports for 10/100/1000Base-T and two SFP ports for the fiber ring or non-ring (100Base-Fx or 1000Base-X)
- ▲ Ring reconfiguration in the case of cable or switch failures takes less than two milliseconds per hop
- ▲ MDI/MDIX Crossover: no need for crossover cables
- ▲ Supports IEEE802.3af/at/bt PoE and PoH
- ▲ Provides up to 95W to each RJ45 port with a total power budget of 240W
- ▲ Auto-Negotiation for half or full duplex operation
- ▲ Integrates with third party NMS system via industry standard SNMP v1, v2c, v3
- ▲ Powered by non-critical 46 to 57VDC supplies with dual power supply inputs
- ▲ Supports 10KB jumbo frames
- ▲ Supports VLAN and IGMP v1, v2, v3 snooping
- ▲ Port security guaranteed with MAC binding function
- ▲ Remote PoE on/off control and status monitoring
- ▲ Redundant ring operation is compatible with all OSD22** series Gigabit Ethernet switches
- ▲ Operates over temperature range of -40°C to +75°C
- ▲ DIN rail wall mounting
- ▲ Available for operation in ring, bus or point-to-point configuration

1.2 TYPICAL SYSTEM DESIGN

Figure 1 below indicates a possible set-up for an OSD2284P system.

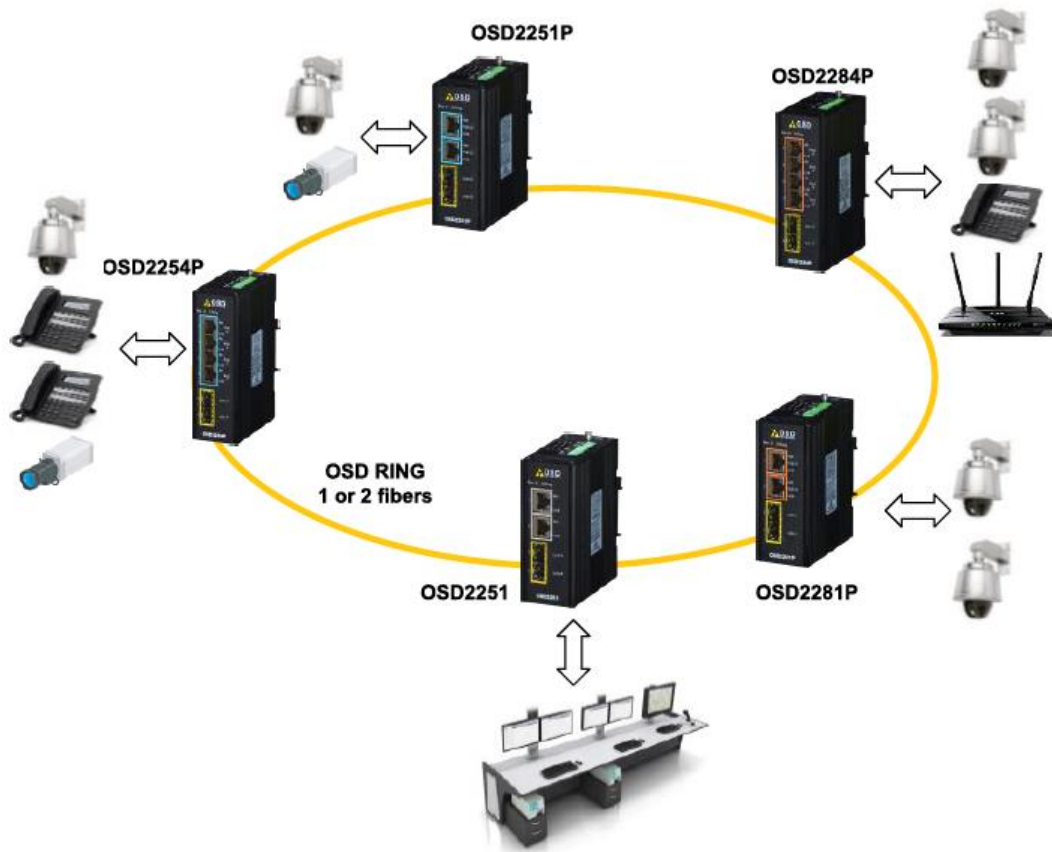

FIGURE 1: TYPICAL SYSTEM DESIGN

1.3 TECHNICAL SPECIFICATIONS

TABLE 1: TECHNICAL SPECIFICATIONS

Hardware	
Ethernet	4 x 10/100/1000Base-T RJ45, IEEE802.3i/802.3u/802.3ab
Jumbo Frame Support	10KB
SFP	2 x Gigabit SFP ports (100Mbps or 1000Mbps user selectable)
Optical Data Interface	IEEE802.3z 1000Base-Lx/Sx, IEEE802.3u 100Base-Fx
PoE (user configurable via GUI)	IEEE802.3af/at, IEEE802.3bt, HDBase-T (PoH) Up to 95W per port with total power budget of 240W Additional PoE modes available via Web-GUI
Enclosure Protection Class	IP30
Installation	DIN rail, wall mount or desktop
Alarm (ring version only)	Ring to Bus, High Temperature
Alarm Interface	Opto isolated MOSFET rated at 100mA @ 46V maximum
Alarm Connector	4 way 3.5mm terminal block
DIP Switch	8 way DIP switch for configuration
Power Requirements	46 to 57V _{DC} @ 8VA maximum (no PoE in use) to 256VA maximum (All 4 ports supplying 60W PoE power) >52V _{DC} recommended for PoE <30W or ≥55V _{DC} for PoE >30W
Output PoE Vdrop per port	PoE voltage drop per port <0.5V @ 30W, <1V @ 60W
Power Connector	4 way 5.08mm terminal block
Indicators	4 x Copper Link on each RJ45 4 x Copper Activity on each RJ45 4 x PoE Active on each RJ45 2 x SFP Speed/Activity/Link on each SFP 1 x Initialise/Ring/Bus 1 x Power/Temperature Alarm
Environmental	-40 to +75°C
Relative Humidity	0 to 95% non-condensing
Dimensions	43W x 91D x 130H mm
Weight	680g
Management	
Interfaces	Command Line Interface (CLI) (mini USB) Web browser based Graphical User Interface (GUI) (Chrome or Edge browser) SNMP v1, v2c, v3
Port Configuration	Port enable/disable, Auto negotiation
Port Status	Speed, duplex mode, link status, auto negotiation status
Port Security	MAC address binding
VLAN	802.1Q VLAN
Multicast Protocol	RFC 2236 IGMP snooping v1, v2, v3
Ethernet Redundancy	OSD-Ring
SNMP MIBs	RFC 1213 MIB Private MIB framework Contact OSD for full list of available MIBs
Warranty	
Warranty Period	5 years
MTBF (Ground Benign Environment, 30°C)	480,000 hours

1.4 PORT ALLOCATION

Front Panel: There are four fixed copper ports for 10/100/1000Base-T and two SFP ports.

Top Panel: The top panel consists of a 4-way 5.08mm terminal block power connector and a 4-way 3.5mm terminal block alarm connector.

Bottom Panel: 8-Way DIP switch, Mini USB connector and a mini USB connector.

Each section will be described further throughout this manual.

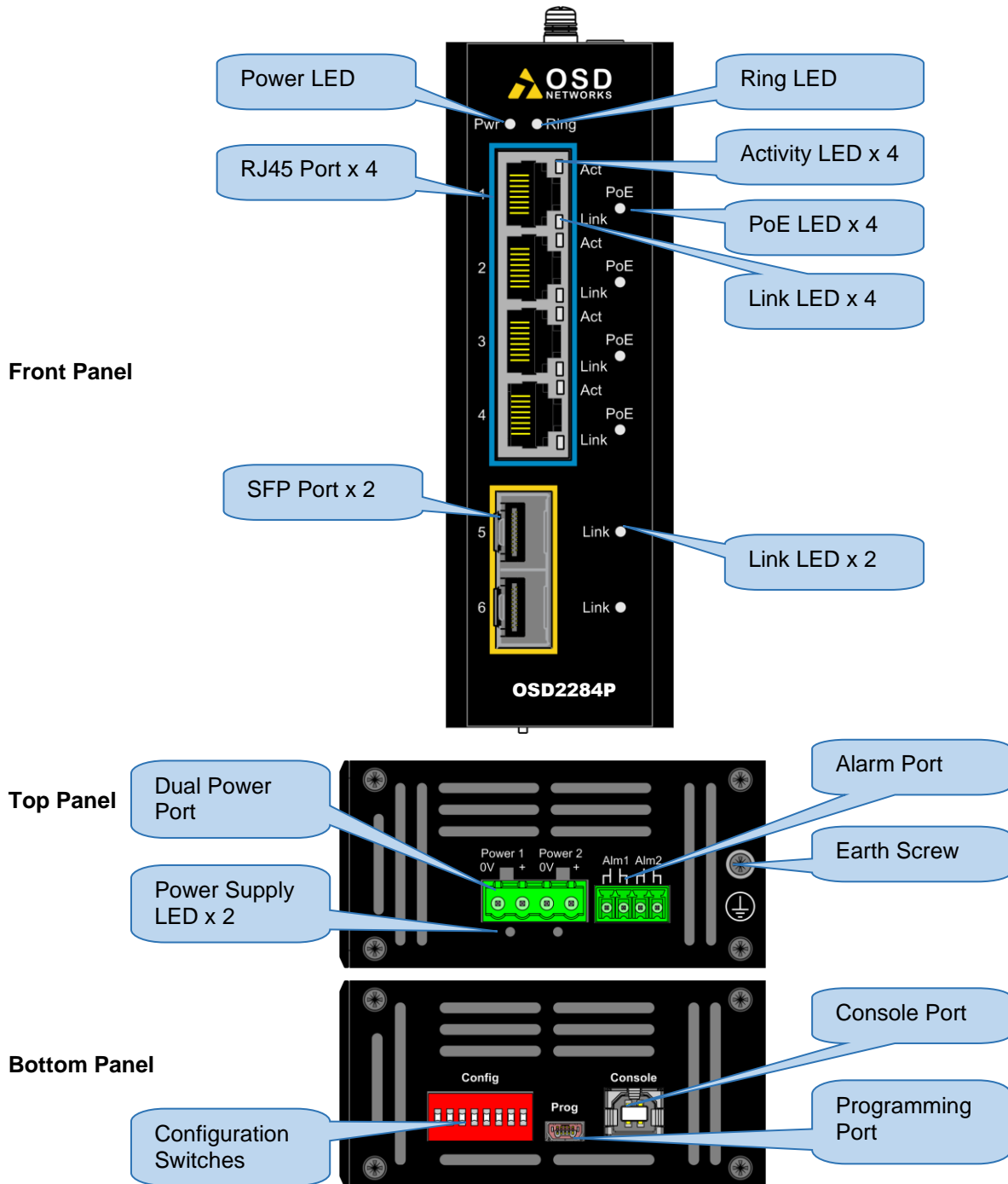

FIGURE 2: PORT ALLOCATION

2 INSTALLATION AND OPERATION

2.1 INTRODUCTION

This section outlines the methods required to install and operate the OSD2284P successfully. It should be studied carefully if damage to the equipment or poor results are to be avoided.

This equipment has been fully tested prior to dispatch and is ready for immediate operation. However, it is advisable to check for external transportation damage before operation. If damage is evident, return the unit with the packaging to your supplier immediately.

2.2 INSTALLATION

2.2.1 WARNING AND PRECAUTIONS

▲ ELECTROMAGNETIC COMPATIBILITY

WARNING: This is a Class A product. In a domestic environment this product may cause radio interference in which case the user may be required to take adequate measures.

▲ OPTICAL OUTPUT OPERATION

WARNING: Laser Safety: Class 1 Laser Product per IEC/EN 60825-1:2014 standard.

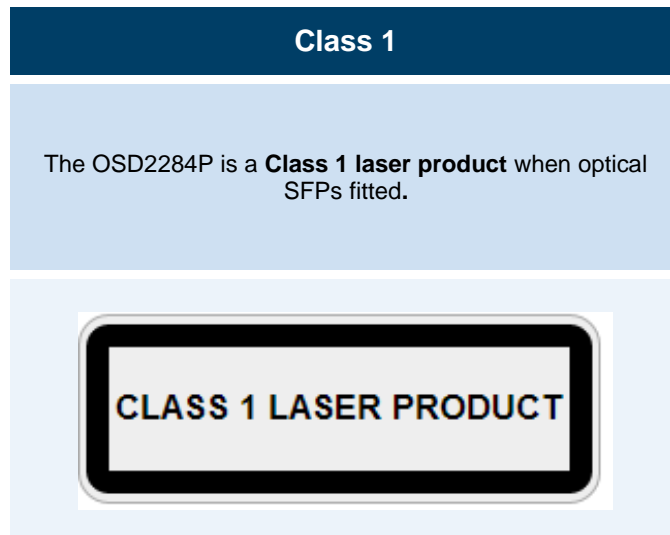

PRECAUTIONS

- ▲ All service personnel should be provided training as to the hazards of direct viewing of laser radiation and of the precautionary measures during servicing of equipment
- ▲ Areas where laser products are installed should be restricted in access to trained service personnel only and appropriate warning signs posted in the work area.
- ▲ All laser apertures should be covered by protective covers when not connected to optical fibers. Never leave outputs uncovered.
- ▲ Laser equipment should be positioned above or below eye level where possible. Apertures should be positioned away from personnel.
- ▲ Protective eyewear should be worn in the vicinity of laser equipment.

2.2.2 DRAWINGS AND DIMENSIONS

The OSD2284P is designed to be wall mounted onto a DIN-Rail (35mm top hat) fixture or by using 4 x M4 captivated screws (DIN Rail mount requires removal and flanges repositioned – see below). The unit dimensions (excluding connectors, SFPs, etc) is shown in Figure 3 below.

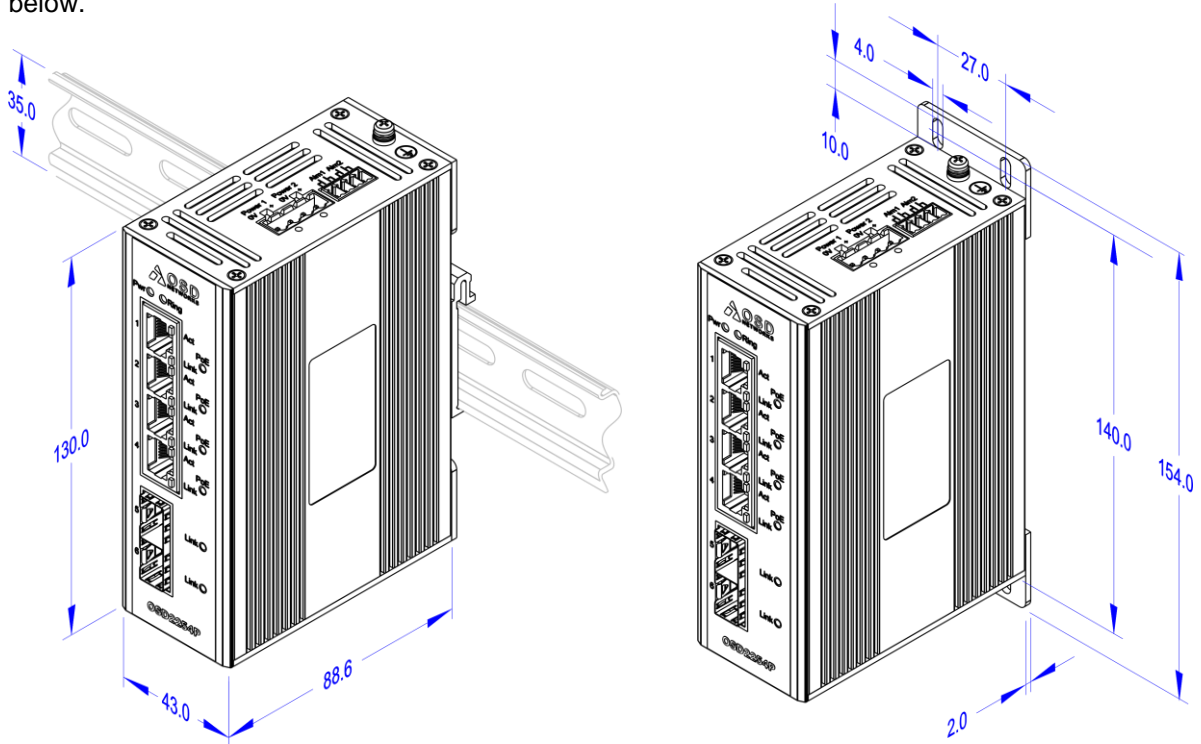

DIN Mount

Wall Mount

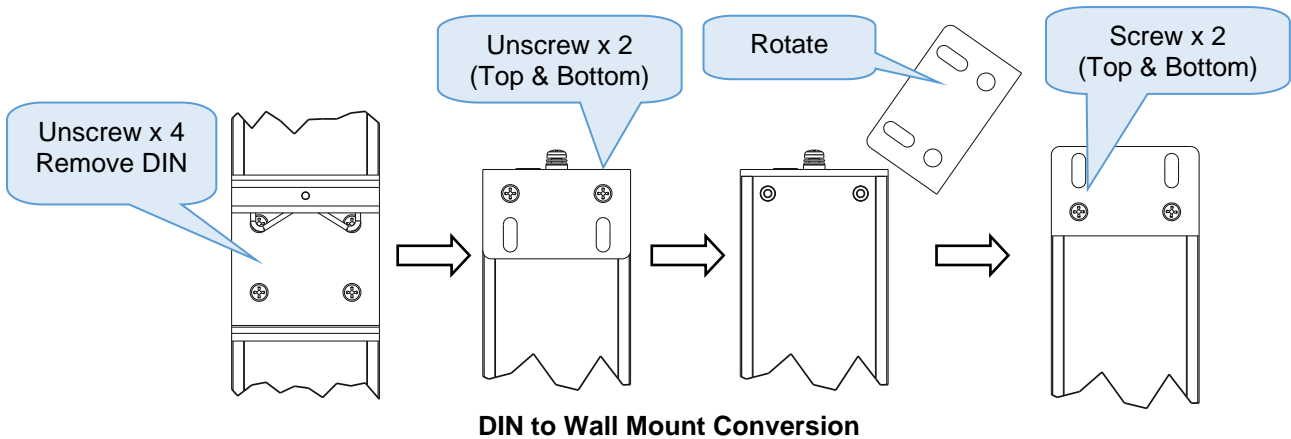

DIN to Wall Mount Conversion

FIGURE 3: MOUNTING DIMENSIONS

2.2.3 LOCATION

As with any electrical device, the OSD2284P should be placed where the switch will not be subjected to extreme temperatures, humidity, or electromagnetic interference. Specifically, the site selected should meet the following requirements:

- The ambient temperature should be between -40°C to 75°C.
- The relative humidity should be less than 95 percent, non-condensing.
- Surrounding electrical devices should not exceed the electromagnetic field (RFC) standards.
- Make sure that the switch receives adequate ventilation. Do not block the ventilation holes on any side of the switch.

Note: Without proper cooling and control (lowering) of ambient temperature, the components within the OSD2284P can be subject to increased heat shortening the longevity and reliability. It is thus good engineering practice to ensure the unit is installed in a well ventilated area.

2.2.4 POWER SUPPLY CONNECTIONS

The OSD2284P requires external power to the Redundant DC Terminal Block Power Connector located at the top of the unit. Always ensure that the power is off before any installation.

Redundant DC Terminal Block Power Inputs

There are two pairs of power inputs for use with redundant power sources. Only one power input is required to be connected to run the switch.

Step 1: Connect the DC power to the appropriate power source, connect the plug-able terminal block on the OSD2284P switch and then turn power on.

Step 2: Disconnect the power if you want to shut down the switch.

TABLE 2: POWER CONNECTION

External Power Pin	Specification
Power 1 +	46V _{DC} to 57V _{DC} @ 256VA*
Power 1 0V	Ground – 0V
Power 2 +	46V _{DC} to 57V _{DC} @ 256VA*
Power 2 0V	Ground – 0V
	Earth Ground Connection

*≥52V_{DC} recommended for PoE <30W or ≥ 55V_{DC} for PoE >60W per port

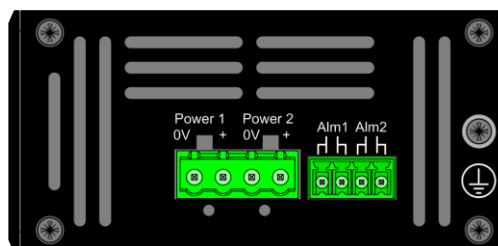

FIGURE 4: POWER SUPPLY CONNECTIONS

2.2.5 ALARM CONNECTION

The OSD2284P has two monitoring alarm outputs: 1) Ring to Bus Alarm and 2) Temperature Alarm. The alarm connections and conditions for alarm outputs are as set out in Table 3. There are four pins on the 3.5mm terminal block used alarm output. Maximum ratings the OSD2284P relay can drive is 100mA @ 46V_(max). Note: Alarm output has no polarity.

TABLE 3: ALARM CONNECTIONS

Alarm Output	Alarm 1 Ring /Bus Status	Alarm 2 Temperature
Open	Ring	Less than 80°C
Closed	Bus*	Higher than 80°C

*Note: Bus alarm is only triggered *after* a ring connection is established.

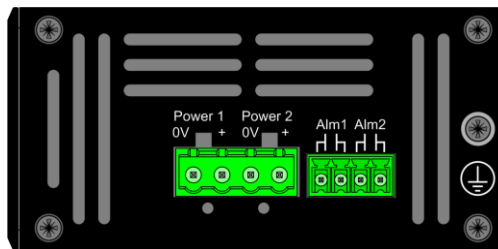

FIGURE 5: ALARM OUTPUTS

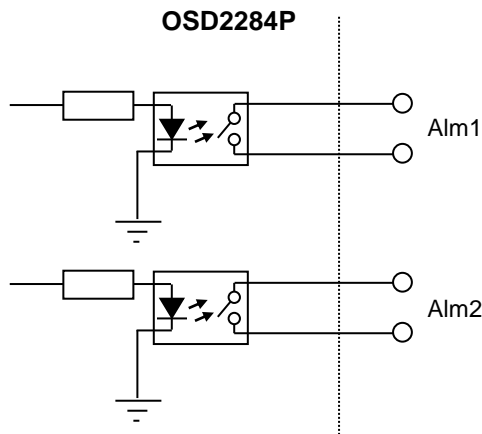

FIGURE 6: CONTACT CLOSURE OUTPUT

2.2.6 USB CONNECTOR

The OSD2284P has a Type B USB connector located on the bottom of the unit that is used for Command Line Interface (CLI) from the PC to the OSD2284P via the PC's USB connector. See section 2.4 for further CLI information.

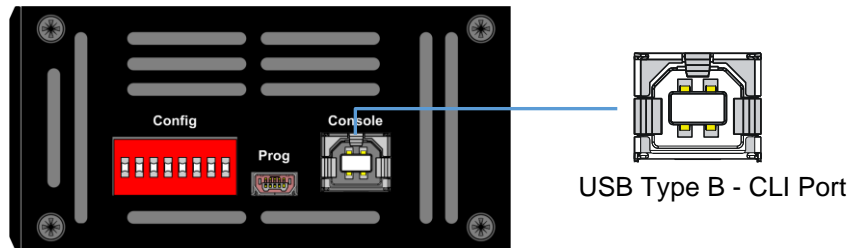

FIGURE 7: USB TYPE B CLI PORT

To operate and control the OSD2284P using the CLI, a proprietary driver will be required to be installed onto the PC being used. The driver can be found and downloaded via the following site: www.silabs.com and searching for the CP210x driver. Download the relevant driver for your operating system, install and follow the installation instructions from your PC.

Download for Windows 10 Universal (v10.1.7)

Platform	Software	Release Notes
Windows 10 Universal	Download VCP (2.8 MB)	Download VCP Revision History

Download for Windows 7/8/8.1 (v6.7.6)

Platform	Software	Release Notes
Windows 7/8/8.1	Download VCP (5.9 MB) (Default)	Download VCP Revision History
Windows 7/8/8.1	Download VCP with Serial Enumeration (5.3 MB) Learn More >	Download VCP Revision History

Download for Windows XP/Server 2003/Vista/7/8/8.1 (v6.7)

Platform	Software	Release Notes
Windows XP/Server 2003/Vista/7/8/8.1	Download VCP (3.66 MB)	Download VCP Revision History

Download for Windows 2K (v6.3a)

Platform	Software	Release Notes
Windows 2K	Download VCP (4.79 MB)	Download Win2K VCP Revision History

Download for WinCE

Platform	Software	Release Notes
WinCE 6.0 (2.1)	Download VCP (276 KB)	Download WinCE 6.0 Revision History
WinCE 5.0 (2.1)	Download VCP (271 KB)	Download WinCE 5.0 Revision History

Download for Macintosh OSX (v5.1.0)

Platform	Software	Release Notes
Mac OSX	Download VCP (852 KB)	Download Mac VCP Revision History

Download for Linux

Platform	Software	Release Notes
Linux 3.x.x and 4.x.x	Download VCP (18.0 KB)	Download Linux 3.x.x and 4.x.x VCP Revision History
Linux 2.6.x	Download VCP (18.2 KB)	Download Linux 2.6.x VCP Revision History

*Note: The Linux 3.x.x and 4.x.x version of the driver is maintained in the current Linux 3.x.x and 4.x.x tree at www.kernel.org.

Download for Android

Platform	Application Note
Android 4.2	AN809: Integrating the CP210x Virtual COM Port Driver into the Android Platform

FIGURE 8: CLI INSTALLATION

2.2.7 MINI USB PORT

The Mini USB Port is used for uploading firmware updates. All OSD2284P units will be shipped with the latest firmware already installed. This port has no function for end user.

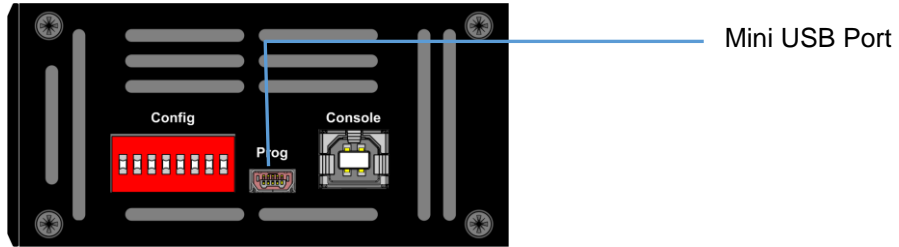

FIGURE 9: USB CONNECTOR

2.2.8 LED INDICATORS

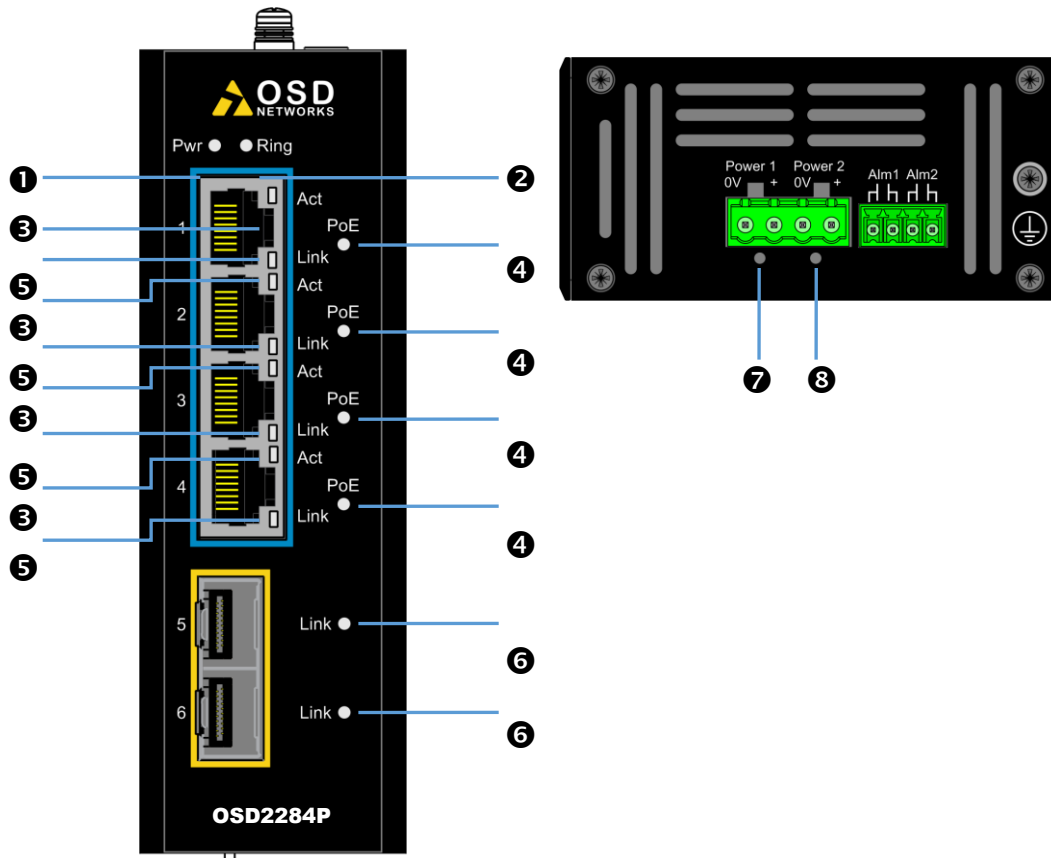

FIGURE 10: PORT/LED

TABLE 4: LED FUNCTION

No	Function			LED Colour Function			
	On	Blink	Off	Green	Gr/Am	Amber	Blink
1	Power	-	No Power	Power	-	-	-
2	Ring/Bus	Initial	Non-Ring	Ring	Initialising	Bus	-
3	-	Activity	No Activity	1G/100Mbps	-	-	-
4	PoE Load Detected	-	No Load	PoE Load Detected	-	-	Non-PoE Load
5	Link	-	No Link	-	-	-	-
6	Fiber Link	Activity	No Link	1Gbps	-	100bps	-
7	Power Supply 1	-	Not Connected	Power On	-	-	-
8	Power Supply 2	-	Not Connected	Power On	-	-	-

2.2.9 CONTROLS

The OSD2284P has an 8-way DIP switch to control a number of functions. Table 5 outlines the function of each switch.

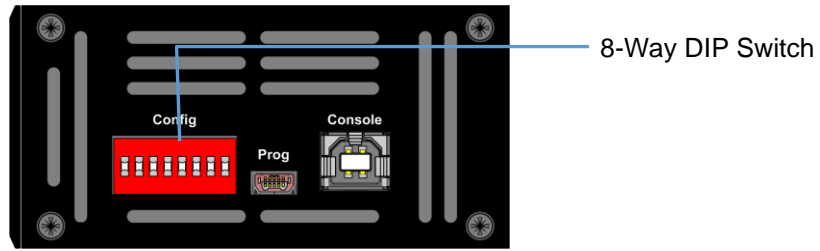

FIGURE 11: CONTROLS

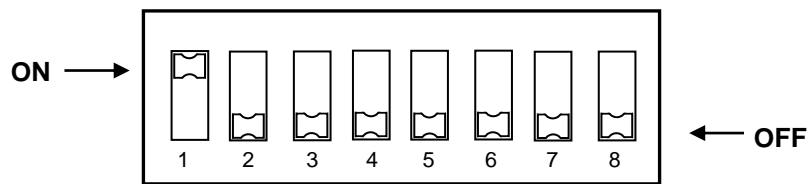

FIGURE 12: 8-WAY DIP SWITCH

TABLE 5: 8-WAY DIP SWITCH SETTINGS

Switch Number	Description	Function	Switch Position
1	GUI Mode	GUI Enabled	ON*
		GUI Disabled	OFF
2	PoE Mode	See Table 6 for PoE Mode Function	OFF*
3	PoE Mode	See Table 6 for PoE Mode Function	OFF*
4	High Inrush Function	Enabled	ON
		Disabled	OFF*
5	Ring/Bus	Non-Ring	ON
		Ring	OFF*
6	Port 5 Fiber Speed	100Mbps	ON
		1000Mbps	OFF*
7	Port 6 Fiber Speed	100Mbps	ON
		1000Mbps	OFF*
8	Reserved	Erase Mode	ON
		Normal Operation/User Mode	OFF*

* Default settings.

† At Off position and power-up, unit will switch to default settings.

Note: The unit requires a power cycle (Off/On) for any switch position change to take effect.

TABLE 6: POE MODE SWITCH SETTINGS

PoE [2]	PoE [3]	PoE Function
0*	0*	WebGUI PoE Enabled (802.3bt 4 Pairs Standard Mode)
0	1	802.3bt 4 Wire 90W Max
1	0	PoH 90W Max
1	1	Disable PoE

* Default settings

2.2.10 FITTING SFP CONNECTORS

Care should be taken when inserting/removing the SFP connectors from SFP port 5 and 6 as SFP modules are Electrostatic (ES) sensitive and Electrostatic Discharge (ESD) precautions should be taken when installing. Ensure that the SFP is fully engaged and latched into position.

Inserting SFP – Ensure that the SFP lever is in the locked position and insert into appropriate SFP port. Gently push the SFP until it locks into place. Remove plastic/rubber dust cap and fit fiber cable or RJ45 plug.

Removing SFP – Remove fiber connector or RJ45 plug. Pull the SFP lever down to unlock SFP from housing. Using the lever, gently pull the SFP out.

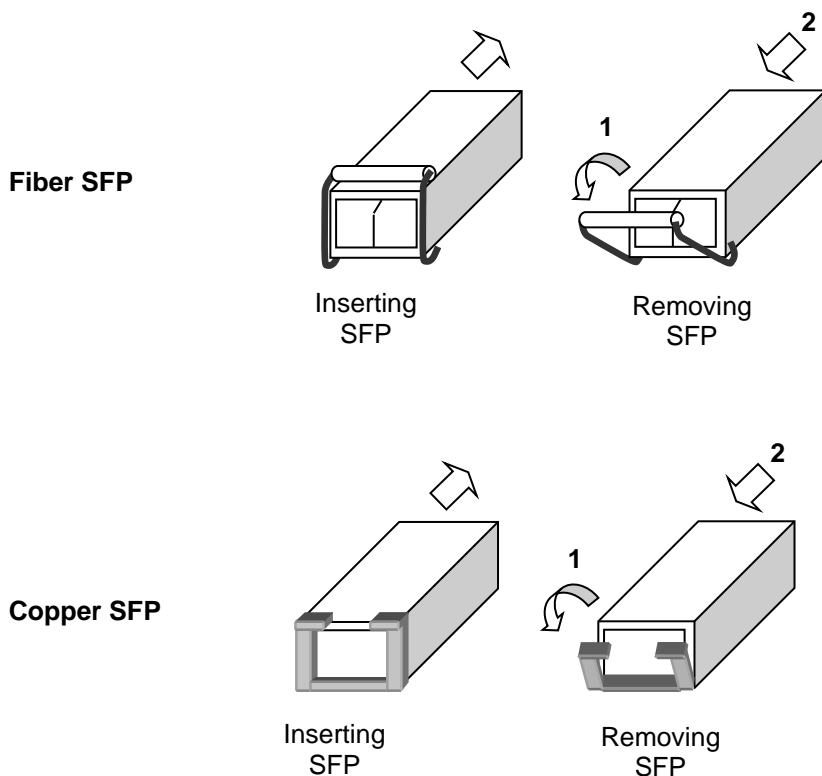

FIGURE 13: FITTING/REMOVING SFP CONNECTORS

2.3 OPERATION

When using the OSD2284P for the first time, check that the unit is in good condition with no visible damage.

Upon power up check that the indicators illuminate accordingly on power up (see Table 4).

2.3.1 CONNECTIONS

For RJ45 connection use Category 5 (CAT5) or higher. Length should be no more than 100 meters.

For singlemode fiber connections, fiber used must be 9/125µm singlemode fiber.

For multimode fiber connections, fiber used must be 50/125µm or 62/125µm multimode fiber.

Plug in the appropriate connectors for system configuration;

- RJ45 cable to fixed copper ports (port 1 and 2) and copper SFP modules
- LC or SC fiber cable to fiber SFP modules.

Redundant Ring Operation

The OSD2284P connected in a redundant ring topology providing maximum reliability on critical networks (up to 64 nodes per ring). In the event of device or fiber failure the data path will automatically switch to a secondary path in less than 2ms per node to maintain ring network integrity.



FIGURE 14: REDUNDANT RING CONFIGURATION

To connect the OSD2284P in a redundant ring configuration ports 5 and 6 must be used together with fiber SFPs. The non-ring ports (ports 1,2,3 & 4) should be used to connect to your Ethernet devices (eg. Cameras, PLCs, computers, etc.)

Figure 15 shows the connection method. Typically, the SFP used would be a fiber SFP with duplex LC connectors. The dashed line indicates the closed loop, but more OSD2284P units can be connected to the ring as required using this topology. Ensure that the switch settings for port 5 and 6 are set to 1000Mbps (1Gbps) – see Table 5. *Note: connection diagram is for illustrative purposes only. Port 5/6 can be connected in to either port to achieve redundant ring configuration.*

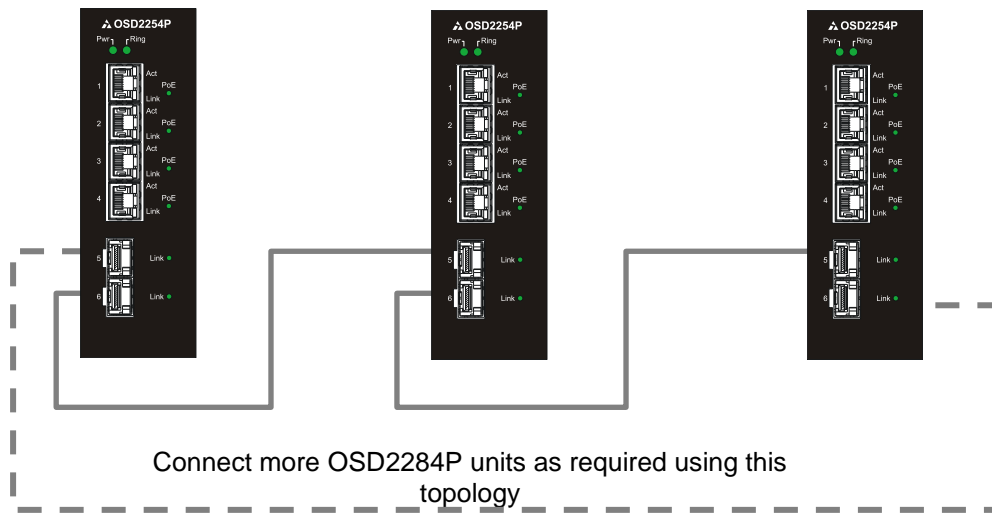

FIGURE 15: REDUNDANT RING CONNECTION

Bus Operation

To connect the OSD2284P in a bus configuration ports 5 and 6 must be used together with fiber SFPs. The remaining ports (ports 1,2,3 & 4) should be used to connect to your Ethernet devices (eg. Cameras, PLCs, computers, etc.)

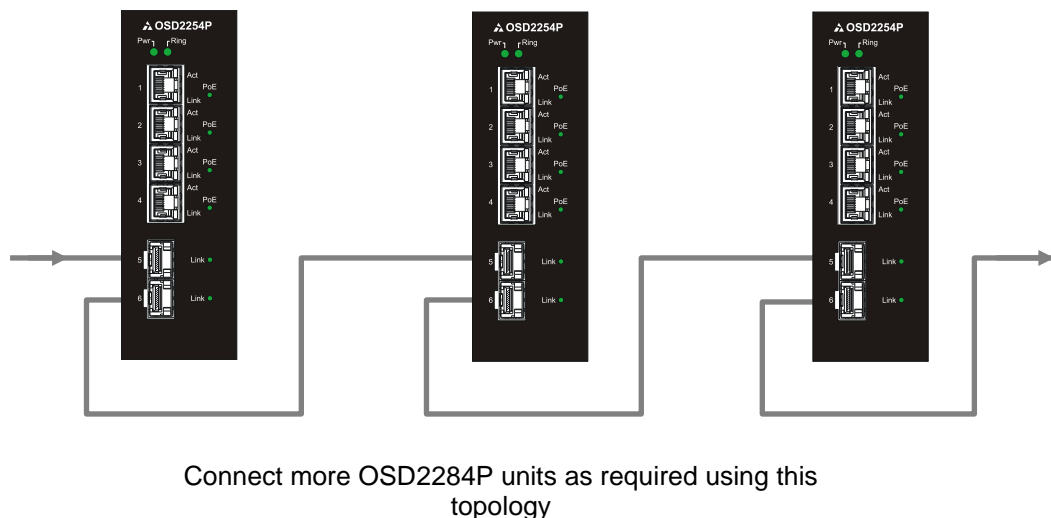

FIGURE 16: BUS CONNECTION

2.4 COMMAND LINE INTERFACE

The Command Line Interface (CLI) is a useful tool for checking link status and debugging link connections. To enable the use of CLI the OSD2284P must be connected to a PC with a serial port and an appropriate cable as specified in section 2.2.6. Using a terminal emulation program such as Hyperterminal, a number of command lines specific to the OSD2284P can be implemented to check link/node status, ring/bus topology and enable/disable float backup.

2.4.1 TERMINAL EMULATION SETUP

Using a terminal emulation program such as hyperterminal the following parameters should be set up for correct command line operation. Select the appropriate “COM port” set up for the serial port.

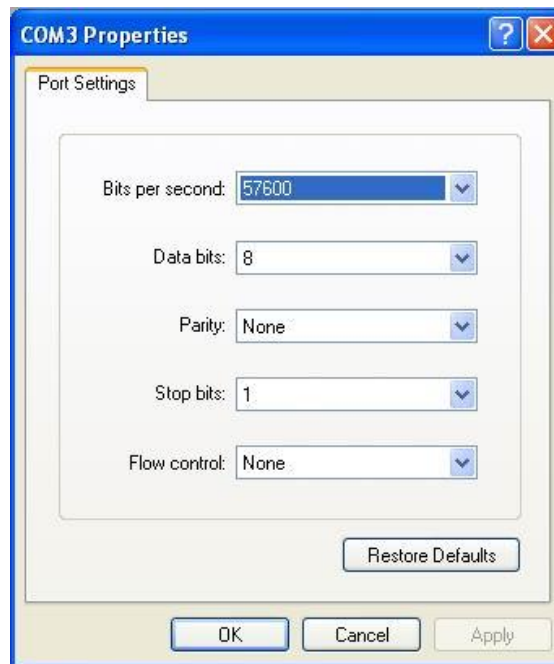

FIGURE 17: SERIAL PORT SETTINGS

2.4.2 COMMAND LINE FUNCTIONS

There are a number of command line functions that enables the user to obtain running information of a single OSD2284P unit or the complete topology of the ring/bus network. This section explains the command lines and its functions.

When the terminal emulation program is operating, connect the USB cable to any one of the OSD2284P units on the ring/bus network – or alternatively, the OSD2284P unit which the user wishes to interrogate. Note: A message will be displayed on the terminal emulation program when the unit is powered after USB connection. This message will not open when the unit is switched on while plugging in the USB cable, however the command lines are functional.

The following table outlines the user available command line commands and their functions

TABLE 7: TERMINAL COMMAND LINES

TERMINAL COMMAND LINE	SPECIFICATION	FUNCTION	FIGURE
?	Help	Lists all CLI commands including input format information	-
vc	Version Check	Displays the current software version and revision installed on the unit	Figure 18
fd	Factory Default	Reset configuration to factory default	Figure 19
ipconfig	IP Configuration	Configure the IP address	Figure 20
tc	Topology Check	Displays the topology status of the established ring/bus	Figure 21
nc	Node Check	Gets running status of the node for given MAC address	Figure 23
lnc	Local Node Check	Gets running status of the local node	Figure 24
fbe	Float Backup Enable	Enable float backup function for all nodes in a Ring/Bus	Figure 25
fbd	Float Backup Disable	Disable float backup function for all nodes in a ring/bus	Figure 29
node_ip_set	Node IP Set	Setup IP of the node with given MAC address	Figure 32
node_all_set	Node All Set	Setup IP for all nodes on a ring/bus	Figure 33
reboot	Reboot	Reboot the device in the network	Figure 34
config_snmp	Configure SNMP	Change to SNMP sub menu	Figure 35
portctrl	Port Control	Enables/Disables all ports	Figure 37
portsecurity	Port Security	Change to Port Security configuration sub menu	Figure 38

VERSION CHECK - <vc>



```
$>vc
Software Version: 10
Software ID Number: 60013310
Build Time: 11-11-2021:11:07:51
Product Name: OSD2254EP
$>
```

FIGURE 18: VERSION CHECK

Displays useful information regarding the unit:

- Software Version Number
- Software ID Number
- Build Time
- Product Name

FACTORY DEFAULT - <fd>

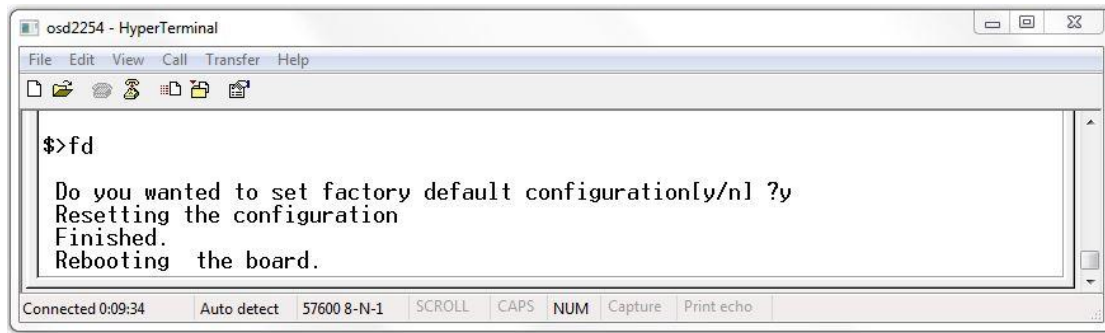
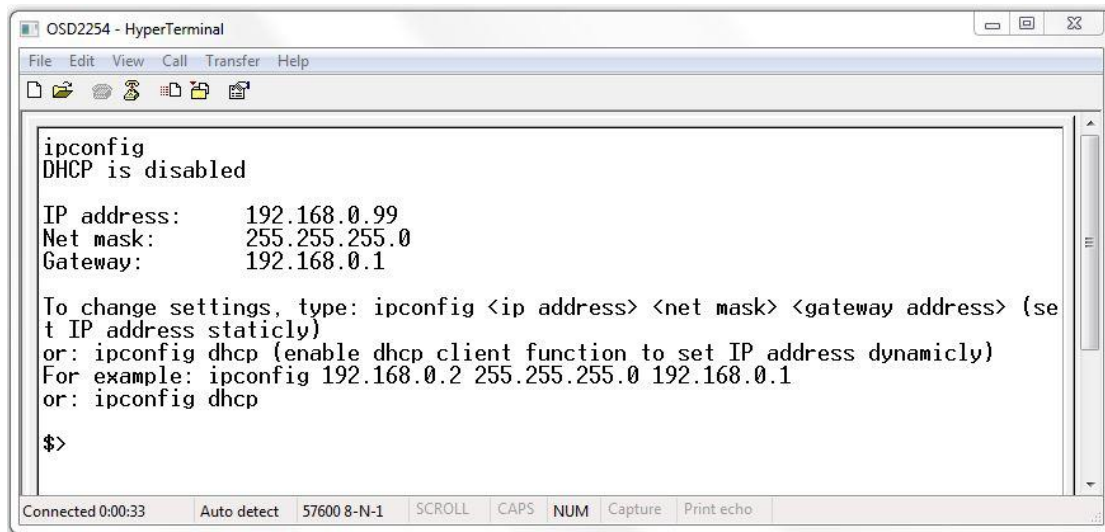

FIGURE 19: FACTORY DEFAULT SETTING

Resets the OSD2284P to its default factory setting. A prompt question will appear “Do you want to Reset Configuration [y/n]?”

- n** – Exits the default configuration setting and returns to the home prompt.
- y** – Resets to default configuration sequence. The units will require a reboot for changes to take effect.

IP CONFIGURATION - <ipconfig>



```

OSD2254 - HyperTerminal
File Edit View Call Transfer Help
ipconfig
DHCP is disabled

IP address:    192.168.0.99
Net mask:     255.255.255.0
Gateway:      192.168.0.1

To change settings, type: ipconfig <ip address> <net mask> <gateway address> (set IP address statically)
or: ipconfig dhcp (enable dhcp client function to set IP address dynamically)
For example: ipconfig 192.168.0.2 255.255.255.0 192.168.0.1
or: ipconfig dhcp

$>

```

FIGURE 20: IP CONFIGURATION

Displays the current IP address, Net mask and Gateway settings. To make changes to the IP address, Net mask and Gateway, at the prompt enter the new details in the following format;

ipconfig <ip address> <netmask> <gateway address>

TOPOLOGY CHECK - <tc>

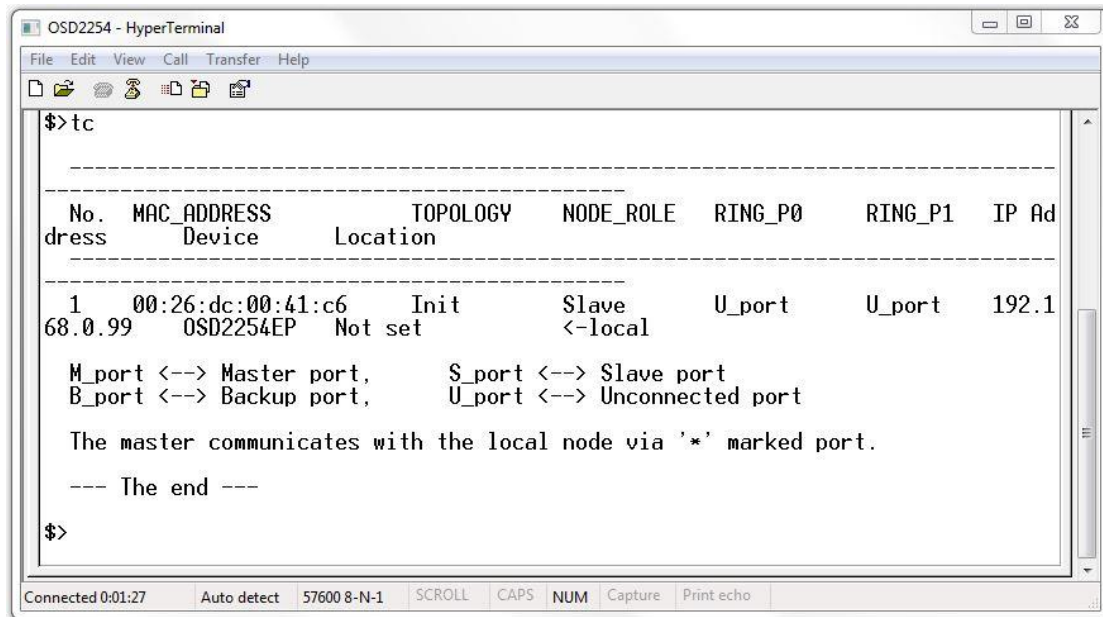

```

OSD2254 - HyperTerminal
File Edit View Call Transfer Help
-----
$>tc
-----
No.  MAC_ADDRESS  TOPOLOGY  NODE_ROLE  RING_P0  RING_P1  IP Ad
dress  Device      Location
-----
1    00:26:dc:00:41:c6  Init      Slave      U_port    U_port    192.1
68.0.99  OSD2254EP  Not set   <-local
-----
M_port <--> Master port,      S_port <--> Slave port
B_port <--> Backup port,      U_port <--> Unconnected port

The master communicates with the local node via '*' marked port.

--- The end ---
$>
-----
Connected 0:01:27  Auto detect  57600 8-N-1  SCROLL  CAPS  NUM  Capture  Print echo

```

FIGURE 21: TOPOLOGY CHECK

In this case, only one OSD2284P is connected to the USB cable. The display indicates the following;

No: 1 – Number of units connected on the ring/bus (in this case only one unit)

MAC_ADDRESS: 00:26:dc:00:1e:28 – Displays all the MAC addresses of the units connected on the ring/bus

TOPOLOGY: Init – Displaying type of connection (in this case “Init” as there is only one unit)

NODE_ROLE: Slave – Displays whether the unit is either the Master or Slave on the ring/bus (in this case displaying slave). The Master unit is determined by the unit with the lowest MAC address

RING_P0: U_port. Indicates the function of port 5 and its relation to the ring/bus. There are four possibilities;

1. M_port – Master Port (port facing the master)
2. S_port – Slave Port (port back to the master)
3. B_Port – Backup Port
4. U_Port – Unconnected Port

RING_P1: U_port. Indicates the function of port 6 and its relation to the ring/bus. There are four possibilities;

1. M_port – Master Port
2. S_port – Slave Port
3. B_Port – Backup Port
4. U_Port – Unconnected Port

<-local: This points to the unit that the USB cable is plugged into on the ring/bus.

IP Address: Displays the IP address of the unit(s) connected to the Ring/Bus

Device: Displays the device(s) name eg: OSD2284P

Location: Displays the set location of the device(s)

In the example below there are four OSD2284P connected in a ring configuration.

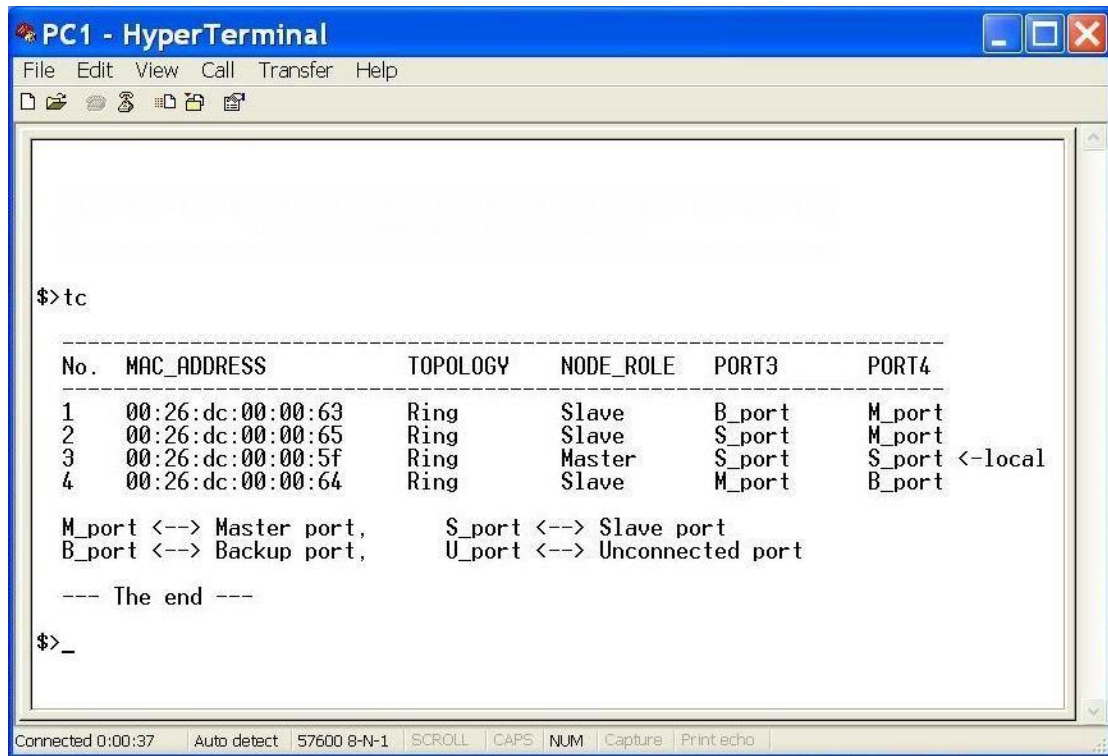

FIGURE 22: TOPOLOGY CHECK

No: 4 – Four units connected

MAC_ADDRESS:– Displaying all the MAC addresses of the units connected on the ring/bus

TOPOLOGY: Ring – Displaying type of connection.

NODE_ROLE: MASTER – Displays if the unit is either the Master or Slave on the ring/bus. Master is determined by the lowest MAC address

PORT3: U_port. Indicates the function of port 5 and its relation to the ring/bus. There are four possibilities;

1. M_port – Master Port
2. S_port – Slave Port
3. B_Port – Backup Port
4. U_Port – Unconnected Port

PORT4: U_port. Indicates the function of port 6 and its relation to the ring/bus. There are four possibilities;

1. M_port – Master Port
2. S_port – Slave Port
3. B_Port – Backup Port
4. U_Port – Unconnected Port

<-local: This points to the unit that the USB cable is plugged into on the ring/bus.

NODE CHECK - <nc>

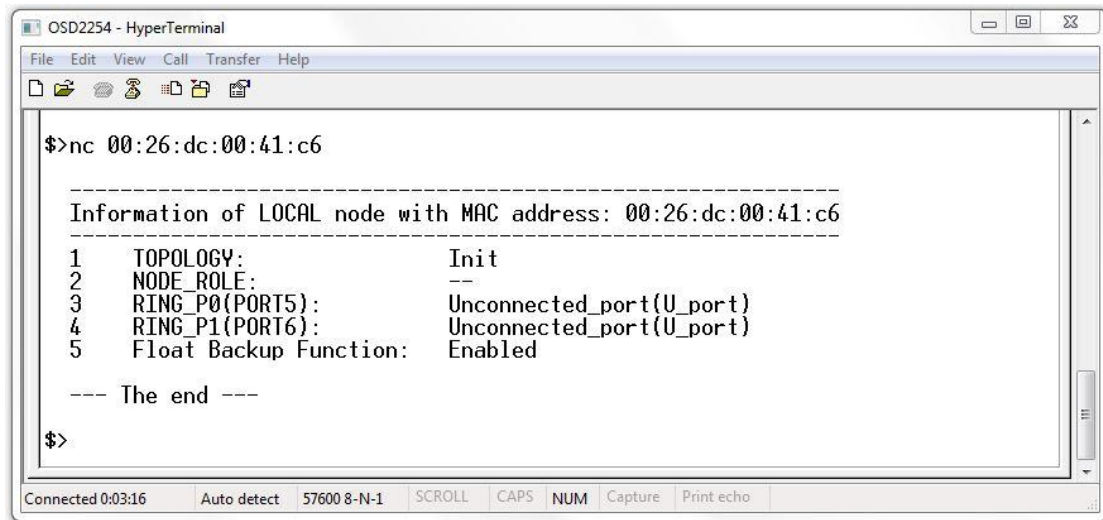

```

OSD2254 - HyperTerminal
File Edit View Call Transfer Help
$>nc 00:26:dc:00:41:c6

-----
Information of LOCAL node with MAC address: 00:26:dc:00:41:c6
-----
1  TOPOLOGY:           Init
2  NODE_ROLE:         --
3  RING_P0(PORT5):    Unconnected_port(U_port)
4  RING_P1(PORT6):    Unconnected_port(U_port)
5  Float Backup Function: Enabled

--- The end ---
$>
Connected 0:03:16  Auto detect  57600 8-N-1  SCROLL  CAPS  NUM  Capture  Print echo

```

FIGURE 23: NODE CHECK

Node check obtains the running status of the node for the specific MAC address requested within the Ring/Bus.

Correct entry format is as follows (MAC address specified below is an example);

nc 00:26:dc:00:42:c6

LOCAL NODE CHECK - <Inc>

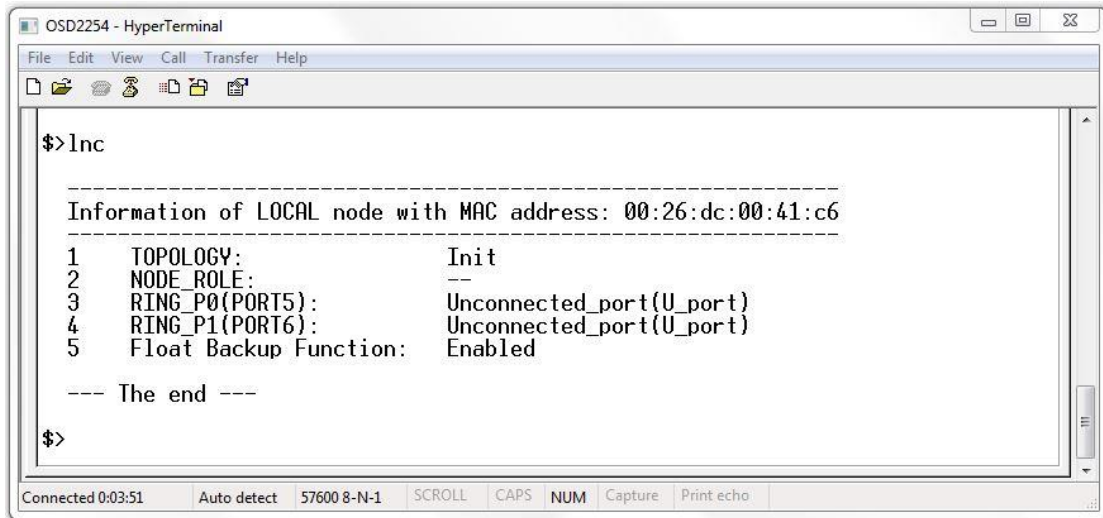

```

OSD2254 - HyperTerminal
File Edit View Call Transfer Help
$>Inc
-----
Information of LOCAL node with MAC address: 00:26:dc:00:41:c6
-----
1  TOPOLOGY:           Init
2  NODE_ROLE:         --
3  RING_P0(PORT5):    Unconnected_port(U_port)
4  RING_P1(PORT6):    Unconnected_port(U_port)
5  Float Backup Function: Enabled

--- The end ---
$>
Connected 0:03:51  Auto detect  57600 8-N-1  SCROLL  CAPS  NUM  Capture  Print echo

```

FIGURE 24: LOCAL NODE CHECK

This command line displays the running status of the local node that the USB cable is plugged into. The information provided is the MAC address, Topology, Node Role, Port Role and Float Backup status.

FLOAT BACKUP ENABLE <fbe>

```

OSD2254 - HyperTerminal
File Edit View Call Transfer Help
$>fbe
-----
No.  MAC_ADDRESS          FLOAT_BACKUP  SETTING_RESULT
-----
1    00:26:dc:00:41:c6     Enable       OK             <-local
-----
--- The end ---
$>

```

Connected 0:04:44 Auto detect 57600 8-N-1 SCROLL CAPS NUM Capture Print echo

FIGURE 25: FLOAT BACKUP ENABLED 1

No: 1 – Lists number of units connected (in this case 1)

MAC_ADDRESS:– Displaying all the MAC addresses of the units connected on the ring/bus

FLOAT_BACKUP: Enable – Displays all the units connected to the ring/bus having Float Backup enabled.

SETTING_RESULT: OK – Displays the Float Backup enable has been successfully implemented.

<-local: This points to the unit that the USB cable is plugged into on the ring/bus.

The link furthest from the Master unit in a ring configuration is automatically selected as the backup branch. In the case of even units on a ring the fiber link on port 5 will always be the backup branch – indicated by a dashed line on a ring topology.

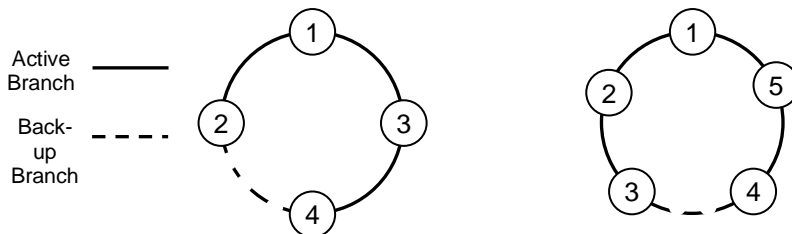

FIGURE 26: RING TOPOLOGY

In Figure 26, node 1 will communicate with node 2, node 3 and node 4 via node 3. Node 2 will communicate to node 4 only via node 1 and 3.

In the event of a fiber link being broken or disconnected (indicated by a cross) the backup branch will become the active branch. If the link between node 1 and 3 is broken (see Figure 27), node 1 will communicate with node 3 via node 2 and node 4.

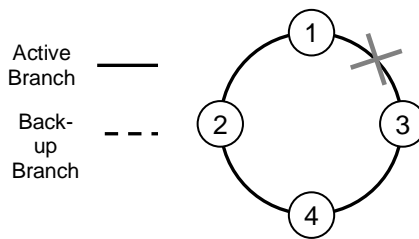

FIGURE 27: FLOAT BACKUP ENABLED 2

When the float backup is in enabled mode, if the broken or disconnected branch is re-established, the backup branch will now be the last broken/disconnected branch as shown in Figure 28.

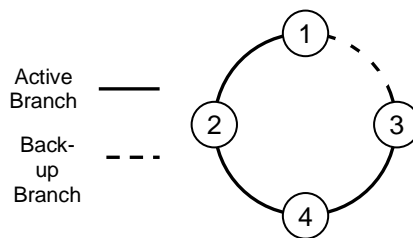
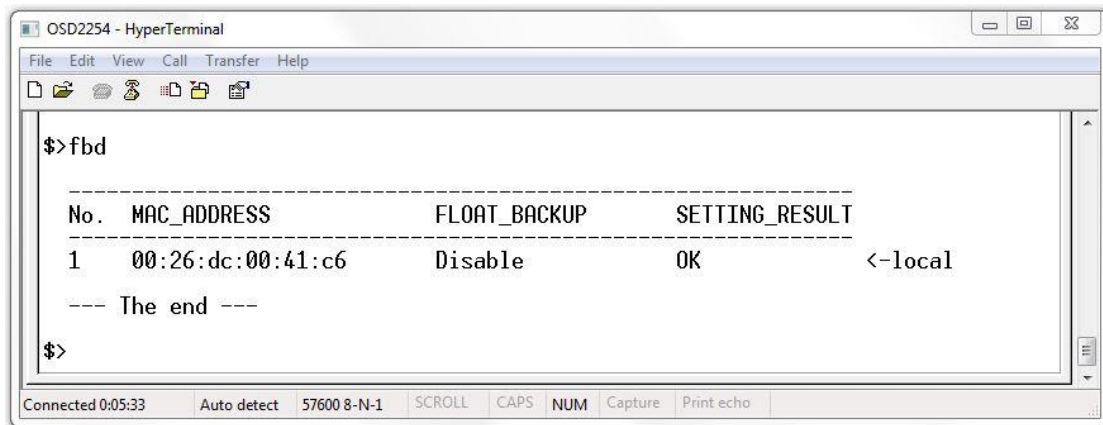

FIGURE 28: FLOAT BACKUP ENABLED 3

Note: When configuring the float backup function **all** units on the ring/bus network **must** have the same float backup configuration for correct operation. Differing backup configurations will cause segmented backup branches and may not function as intended.

All OSD2284P are set to **enabled** float backup upon shipment.

FLOAT BACKUP DISABLE - <fbd>



```

OSD2254 - HyperTerminal
File Edit View Call Transfer Help
$>fbd
-----
No.  MAC_ADDRESS          FLOAT_BACKUP  SETTING_RESULT
-----
1    00:26:dc:00:41:c6      Disable      OK
-----
<-local
--- The end ---
$>
Connected 0:05:33  Auto detect  57600 8-N-1  SCROLL  CAPS  NUM  Capture  Print echo

```

FIGURE 29: FLOAT BACKUP DISABLED 1

No: 1 – Lists number of units connected (in this case 1)

MAC_ADDRESS:– Displaying all the MAC addresses of the units connected on the ring/bus

FLOAT_BACKUP: Disable – Displays all the units connected to the ring/bus having Float Backup disabled.

SETTING_RESULT: OK – Displays the Float Backup disable has been successfully implemented.

<-local: This points to the unit that the USB cable is plugged into on the ring/bus.

The link furthest from the Master unit in a ring configuration is automatically selected as the backup branch. In the case of even units on a ring the fiber link on port 3 will always be the backup branch – indicated by a dashed line on a ring topology.

In the event of a fiber link being broken or disconnected (indicated by a cross) the backup branch will become the active branch.

If the link between node 1 and 3 is broken (see Figure 30), node 1 will communicate with node 3 via node 2 and node 4.

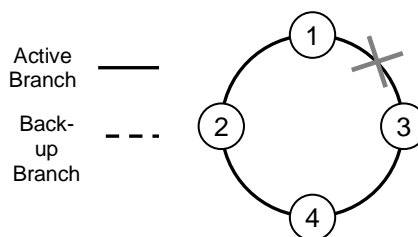

FIGURE 30: FLOAT BACKUP DISABLED 2

When the float backup is in disabled mode, if the broken or disconnected branch is re-established, the backup branch will again be the furthest link from the smallest MAC addressed unit as shown in Figure 31.

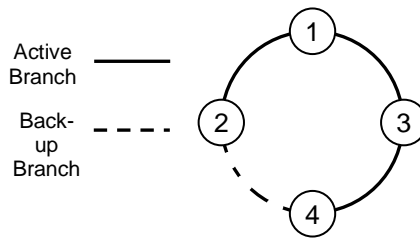
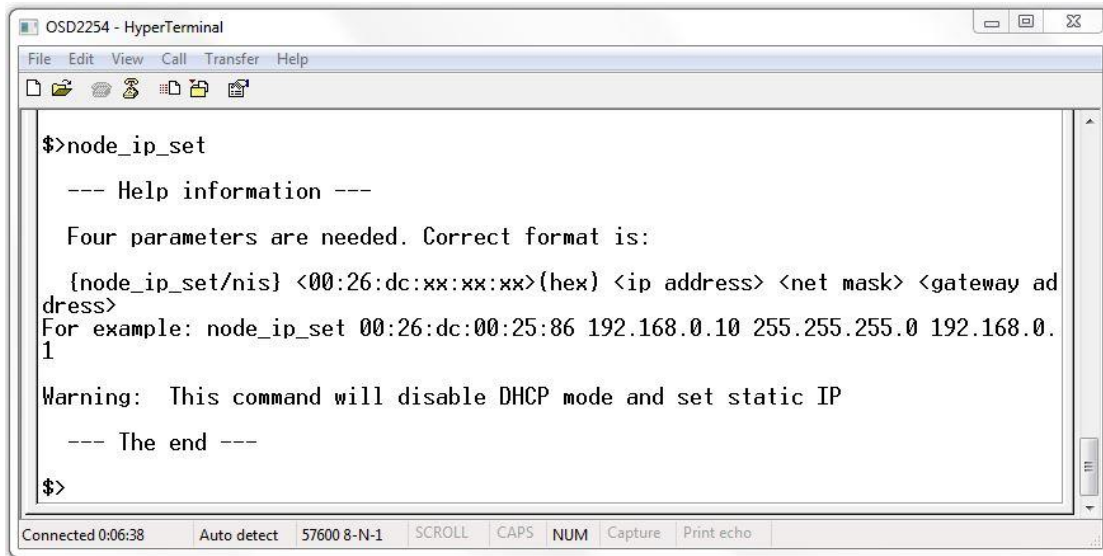

FIGURE 31: FLOAT BACKUP DISABLED 3

Note: When configuring the float backup function **all** units on the ring/bus network **must** have the same float backup configuration for correct operation. Differing backup configurations will cause segmented backup branches and may not function as intended.

All OSD2284P are set to **enabled** float backup upon shipment.

NODE IP SET - <node_ip_set>



```

OSD2254 - HyperTerminal
File Edit View Call Transfer Help
--- Help information ---
Four parameters are needed. Correct format is:
{node_ip_set/nis} <00:26:dc:xx:xx:xx>(hex) <ip address> <net mask> <gateway ad
dress>
For example: node_ip_set 00:26:dc:00:25:86 192.168.0.10 255.255.255.0 192.168.0.
1
Warning: This command will disable DHCP mode and set static IP
--- The end ---
$>
Connected 0:06:38 Auto detect 57600 8-N-1 SCROLL CAPS NUM Capture Print echo

```

FIGURE 32: NODE IP SET

This command line enables the user to setup the IP of the node with the given MAC address. Correct entry format is as follows (MAC, IP, mask and gateway address specified below is an example);

node_ip_set 00:26:dc:00:1e:28 192.168.0.99 255.255.255.0 192.168.0.1

NODE ALL SET - <node_all_set>

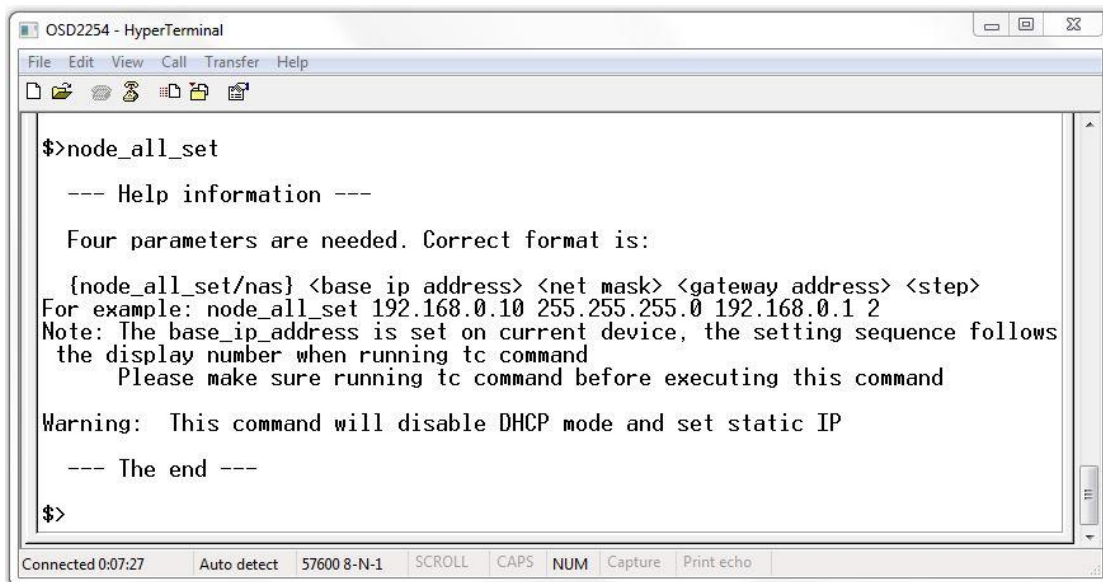

```

OSD2254 - HyperTerminal
File Edit View Call Transfer Help
--- Help information ---
Four parameters are needed. Correct format is:
{node_all_set/nas} <base ip address> <net mask> <gateway address> <step>
For example: node_all_set 192.168.0.10 255.255.255.0 192.168.0.1 2
Note: The base_ip_address is set on current device, the setting sequence follows
the display number when running tc command
Please make sure running tc command before executing this command
Warning: This command will disable DHCP mode and set static IP
--- The end ---
$>
Connected 0:07:27 Auto detect 57600 8-N-1 SCROLL CAPS NUM Capture Print echo

```

FIGURE 33: NODE ALL CHECK

This command line enables the user to setup the IP for all nodes on a ring/bus. Correct entry format is as follows (MAC, IP, mask and gateway address specified below is an example);

node_all_set 192.168.0.99 255.255.255.0 192.168.0.1 2

REBOOT - <reboot/rb>

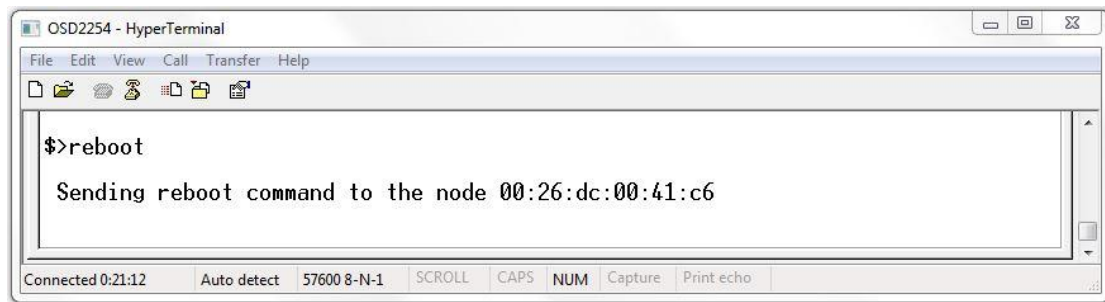

FIGURE 34: REBOOT

This command line enables the user to reboot the device either locally or remotely. *Note: Rebooting should ONLY be used when network failure occurs. Rebooting a properly running network is not advised as network operation may cease.*

Local Reboot

The correct local reboot format is as follows;

reboot/rb <local mac address> or **reboot/rb** Example: `reboot/rb 00:26:dc:xx:xx:xx`

Remote Reboot

The correct remote reboot format is as follows;

reboot/rb <remote mac address> (hex). Example: `reboot/rb 00:26:dc:xx:xx:xx`

Reboot All

Reboots all devices in the network. The correct reboot format is as follows;

reboot/rb all

Note: Reboot All should only be used when a single device reboot does not recover a network failure.

SNMP CONFIGURATION - <config_snmp>



FIGURE 35: SNMP

This command line changes the root path. Typing ? will list the command lines within the SNMP directory. To return to the root directory, type in **return** and hit enter on the keyboard.

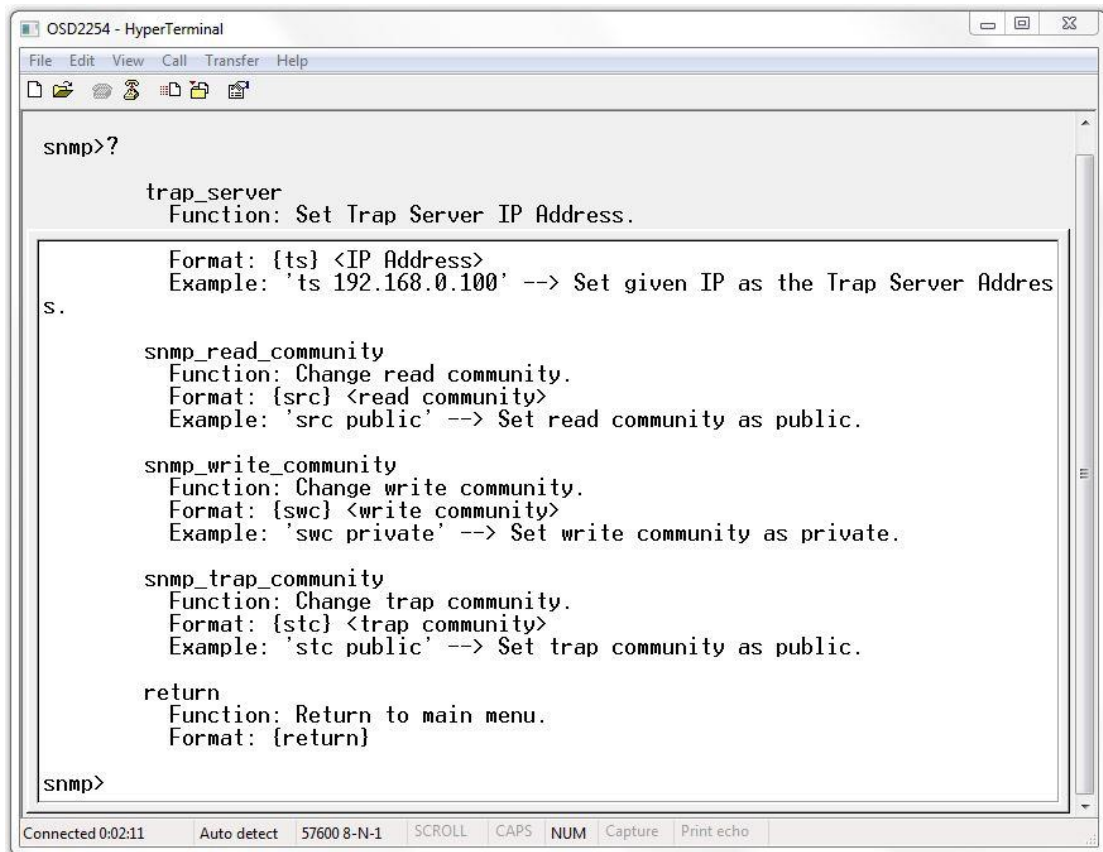

FIGURE 36: SNMP MENU

Set Trap Server <ts>

This command sets the Trap Server IP address. The format is as follows;

ts <IP address>

Example: ts 192.168.0.100

Change Read Community <src>

This command changes the SNMP read community. The format is as follows;

src <read community>

Example: src public

Change Write Community <swc>

This command changes the SNMP write community. The format is as follows;

swc <write community>

Example: swc private

Change Trap Community <stc>

This command changes the SNMP trap community. The format is as follows;

stc <trap community>

Example: stc public

Return to Root Directory <return>

This command returns the CLI to the root directory. The format is as follows;

return

PORT CONTROL - <portctrl>

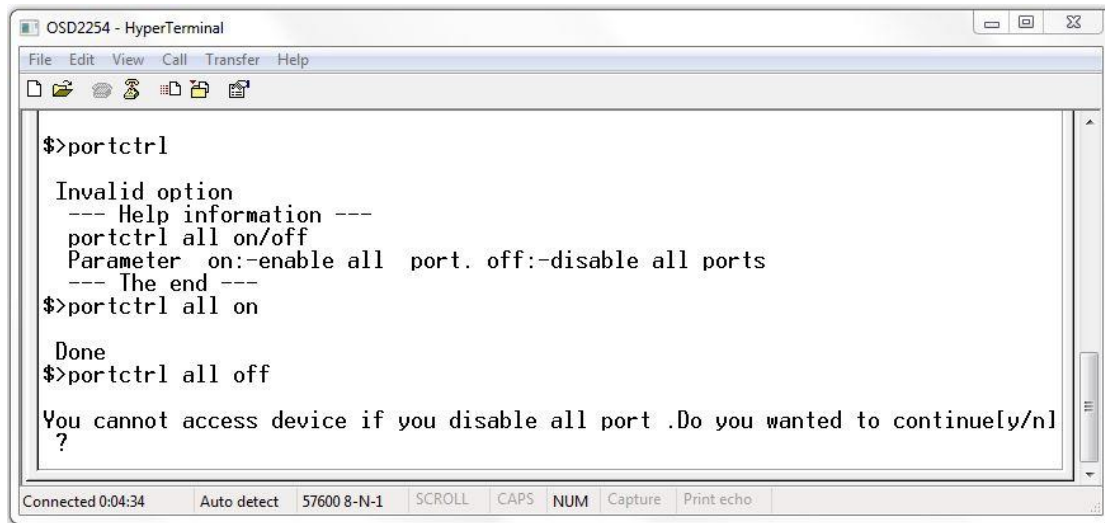

```

OSD2254 - HyperTerminal
File Edit View Call Transfer Help
[Icons]
$>portctrl
Invalid option
--- Help information ---
portctrl all on/off
Parameter on:-enable all port. off:-disable all ports
--- The end ---
$>portctrl all on
Done
$>portctrl all off
You cannot access device if you disable all port .Do you wanted to continue(y/n)
?
Connected 0:04:34 Auto detect 57600 8-N-1 SCROLL CAPS NUM Capture Print echo

```

FIGURE 37: PORT CONTROL

This command line allows the user to enable or disable all 6 ports.

The format to enable all ports is as follows;

portctrl <all> <on>

The format to disable all ports is as follows;

portctrl <all> <off>

Note: A warning message will appear and prompt the user to either select yes or no to continue

n – Exits the port control setting and returns to the root prompt.

y – disables all 4 ports and returns to the root prompt.

PORT SECURITY - <psec>

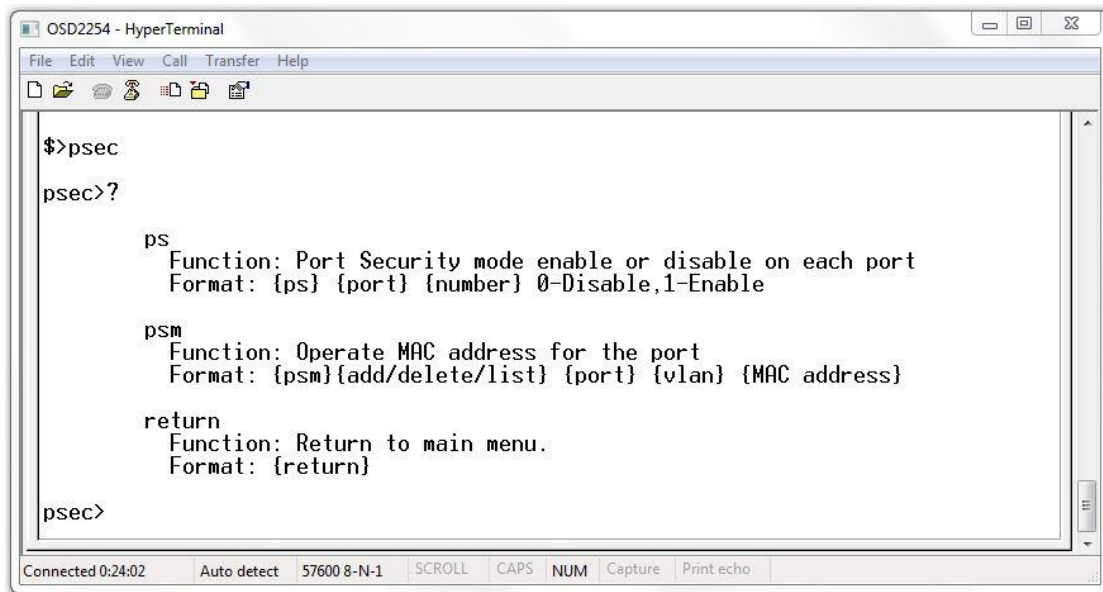

```

OSD2254 - HyperTerminal
File Edit View Call Transfer Help
$>psec
psec>?
    ps
    Function: Port Security mode enable or disable on each port
    Format: {ps} {port} {number} 0-Disable,1-Enable

    psm
    Function: Operate MAC address for the port
    Format: {psm}{add/delete/list} {port} {vlan} {MAC address}

    return
    Function: Return to main menu.
    Format: {return}

psec>
    
```

FIGURE 38: PORT SECURITY

The **psec** command line changes the root path. Typing **?** will list the command lines within the psec directory. To return to the root directory, type in **return** and hit enter on the keyboard.

Port Security Enable/Disable

The format to enable or disable port security on required port(s) is as follows;

ps <port> <number>

- 0 – Disables port security for chosen port.
- 1 – Enables port security for chosen port.

Example: ps 1 0 (disables port security on port 1)

Port Security MAC address

The psm command displays the MAC address security function commands for each port i.e. allows access to the MAC address on each port.

Add – Adds MAC address

psm <add> <port> <vlan> <MAC address>

Eg

```

psec>psm add 3 1000 00:26:dc:22:54:01
Added 00:26:dc:22:54:01 to the list at port 3 VLAN 1000
    
```

Delete – Delete MAC address

psm <delete> <port> <vlan> <MAC address>

Eg

```

psec>psm delete 1 1 00:26:dc:12:34:57
Deleted 00:26:dc:12:34:57 from the list at port 1 VLAN 1
    
```

List – lists the current port security MAC address list
psm <list>

Eg

```

psec>psm list
PORT      vlan      Mac Address
1          1         00:26:dc:12:34:57
1          1         00:26:dc:12:34:59
1          1         00:26:dc:12:34:5a
1          1         00:26:dc:12:34:5b
1          1         00:26:dc:12:34:5c
1          1         00:26:dc:12:34:5d
1          1         00:26:dc:12:34:5e
1          1         00:26:dc:12:34:5f
1          1         00:26:dc:12:34:6c
1          123      00:00:00:00:00:00
2          1         00:26:dc:12:34:56
2          1         00:26:dc:12:34:64
2          1         00:26:dc:12:34:6b
2          2         00:26:dc:12:34:57
3          1000     00:26:dc:22:54:01
3          1         00:26:dc:12:34:60
3          1         00:26:dc:12:34:61
3          1         00:26:dc:12:34:63
3          1         00:26:dc:12:34:6d
4          1         00:26:dc:12:34:62
4          1         00:26:dc:12:34:6a
4          1         00:26:dc:12:34:6e
4          10       00:00:11:11:11:11
  
```

3 WEB GUI

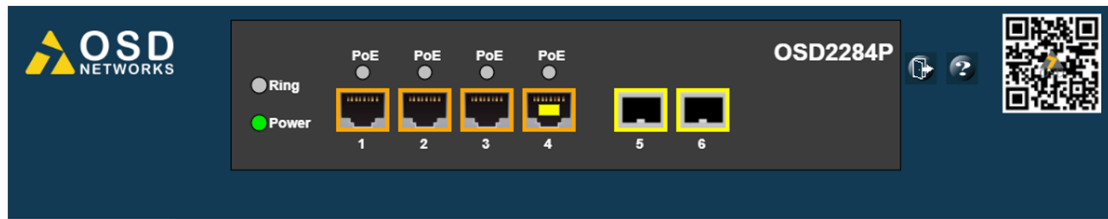

The OSD2284P provides a web-based browser interface for configuring and monitoring the unit. This interface allows you to access the switch using any preferred web browser.

This chapter describes how to configure the switch using its web-based browser interface.

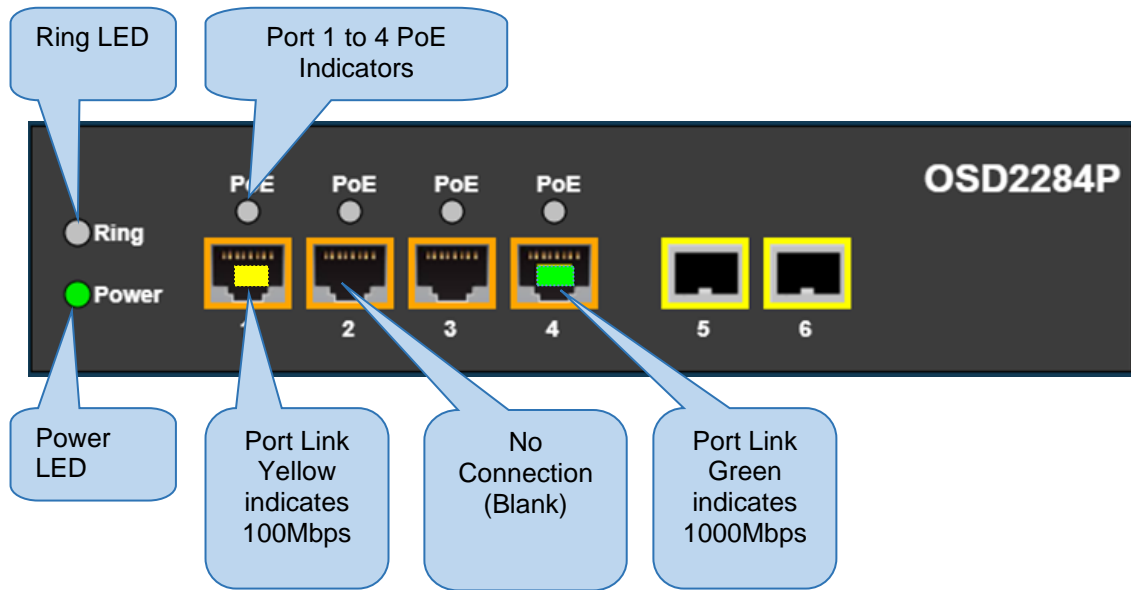

3.1.1 LOGGING ON TO THE SWITCH

SWITCH IP ADDRESS

In your web browser, specify the IP address of the switch. Default IP address is 192.168.0.99

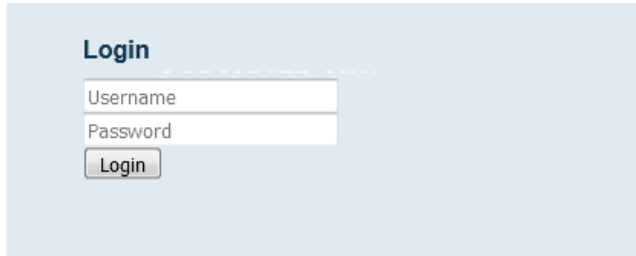

To access the OSD2284P a username and password will need to be entered. *Factory default username is "admin" and no password is set (leave blank) and click Login.*

Upon connecting to the OSD2284P, the home screen will display some useful information. Green/Yellow lighted ports indicating connection to relevant port, Power and Ring LED status.

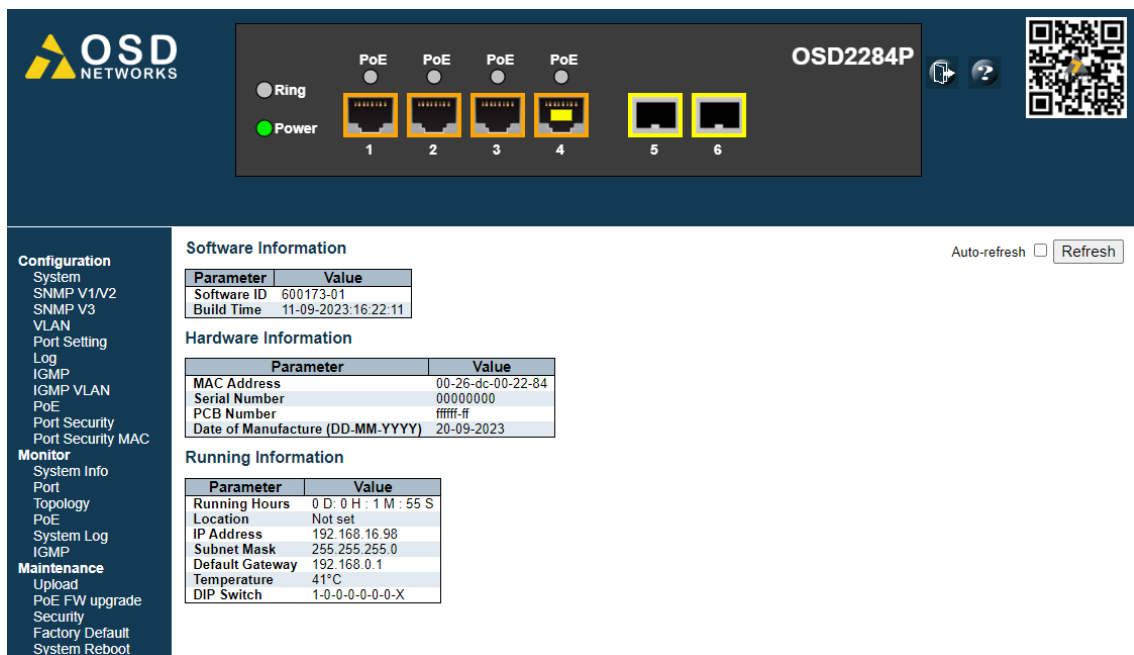

Parameter	Value
Software ID	600173-01
Build Time	11-09-2023:16:22:11

Parameter	Value
MAC Address	00-26-dc-00-22-84
Serial Number	00000000
PCB Number	ffff-ff
Date of Manufacture (DD-MM-YYYY)	20-09-2023

Parameter	Value
Running Hours	0 D : 0 H : 1 M : 55 S
Location	Not set
IP Address	192.168.16.98
Subnet Mask	255.255.255.0
Default Gateway	192.168.0.1
Temperature	41°C
DIP Switch	1-0-0-0-0-0-X

A table displaying useful system information such as MAC address, Serial Number, Software, IP address, etc.

Software Information

Parameter	Value
Software ID	600160-01
Build Time	19-05-2022:16:15:54

Hardware Information

Parameter	Value
MAC Address	00-26-dc-00-22-54
Serial Number	22540001
PCB Number	844701-03
Date of Manufacture (DD-MM-YYYY)	08-06-2022

Running Information

Parameter	Value
Running Hours	0 D: 0 H: 0 M: 15 S
Location	Not set
IP Address	192.168.16.101
Subnet Mask	255.255.255.0
Default Gateway	192.168.0.1
Temperature	33°C
DIP Switch	1-0-0-0-0-0-0-X

3.1.2 GUI MENU



The user has access to Configure, Monitor or Maintain the OSD2284P. Each section will be explained within this manual.

CONFIGURATION → SYSTEM

IP Configuration

	Configured	Last Configured
DHCP enable	Disabled ▾	Disabled
IP Address	192.168.0.99	192.168.0.99
Subnet Mask	255.255.255.0	255.255.255.0
Default Gateway	192.168.0.1	192.168.0.1

Location

	Configured	Current
Location	Not set	Not set

Save Reset

IP Configuration

DHCP ENABLE

Configured: A drop down menu will allow the user to select Enable/Disable

DHCP

Last Configured: Displays the last configured DHCP setting

IP ADDRESS

Configured: The IP address can be changed by modifying this window.

Last Configured: Displays the last configured IP address

SUBNET MASK

Configured: The Subnet Mask can be changed by modifying this window.

Last Configured: Displays the last configured Subnet Mask

DEFAULT GATEWAY

Configured: The Default Gateway can be changed by modifying this window.

Last Configured: Displays the last configured Default Gateway

Location

LOCATION

Configured: The user can set the location of the unit to easily identify its location.

Last Configured: Displays last configured location

Buttons

Save : saves the new settings

Reset : resets any changes made

CONFIGURATION → SNMP V1/V2

SNMP V1/V2 Configuration

Enable V1

Enable V2

	Configured	Current
SNMP Read Community	public	public
SNMP Write Community	private	private
SNMP Trap Community	public	public
SNMP Trap Server IP	192.168.0.100	192.168.0.100

ENABLE V1

- : SNMP V1 is enabled
- : SNMP V1 is disabled

ENABLE V2

- : SNMP V2 is enabled
- : SNMP V2 is disabled

SNMP READ COMMUNITY

Configured: The SNMP Read Community can be changed by modifying this window.

Current: Displays the current saved SNMP Read Community

SNMP WRITE COMMUNITY

Configured: The SNMP Write Community can be changed by modifying this window.

Current: Displays the current saved SNMP Write Community

SNMP TRAP COMMUNITY

Configured: The SNMP Trap Community can be changed by modifying this window.

Current: Displays the current saved SNMP Trap Community

SNMP TRAP SERVER IP

Configured: The SNMP Trap Server IP address can be changed by modifying this window.

Current: Displays the current saved SNMP Trap Server IP Address

Buttons

: saves the new settings

: resets any changes made

CONFIGURATION → SNMP V3

SNMP V3 Configuration

Enable V3

Engine ID

Delete	User Name	Security Level	Authentication Protocol	Authentication Password	Privacy Protocol	Privacy Password
--------	-----------	----------------	-------------------------	-------------------------	------------------	------------------

ENABLE V3

- : SNMP V3 is enabled
- : SNMP V3 is disabled

ENGINE ID

An octet string identifying the engine ID that this entry should belong to. The string must contain an even number (in hexadecimal format) with number of digits between 10 and 64, but all-zeros and all-F's are not allowed. The SNMPv3 architecture uses the User-based Security Model (USM) for message security and the View-based Access Control Model (VACM) for access control. For the USM entry, the `usmUserEngineID` and `usmUserName` are the entry's keys. In a simple agent, `usmUserEngineID` is always that agent's own `snmpEngineID` value. The value can also take the value of the `snmpEngineID` of a remote SNMP engine with which this user can communicate. In other words, if user engine ID equal system engine ID then it is local user; otherwise it's remote user.

DELETE

Check to delete the entry. It will be deleted during the next save.

USERNAME

A string identifying the user name that this entry should belong to. The allowed string length is 1 to 14. The maximum users that can be added are 5.

SECURITY LEVEL

Indicates the security model that this entry should belong to. Possible security models are:

- **NoAuth, NoPriv:** No authentication and no privacy.
- **Auth, NoPriv:** Authentication and no privacy.
- **Auth, Priv:** Authentication and privacy.

The value of security level cannot be modified if entry already exists. That means it must first be ensured that the value is set correctly.

AUTHENTICATION PROTOCOL

Indicates the authentication protocol that this entry should belong to. Possible authentication protocols are:

- **MD5:** An optional flag to indicate that this user uses MD5 authentication protocol.
- **SHA:** An optional flag to indicate that this user uses SHA authentication protocol.

The value of security level cannot be modified if entry already exists. That means must first ensure that the value is set correctly.

AUTHENTICATION PASSWORD

A string identifying the authentication password phrase. For MD5 authentication protocol, the allowed string length is 8 to 32. For SHA authentication protocol, the allowed string length is 8 to 40.

PRIVACY PROTOCOL

Indicates the privacy protocol that this entry should belong to. Possible privacy protocols are:

AES: An optional flag to indicate that this user uses AES authentication protocol.

PRIVACY PASSWORD

A string identifying the privacy password phrase. The allowed string length is 8 to 32.

Buttons

: Click to add new user

: saves the new settings

CONFIGURATION → VLAN

VLAN Configuration

Enable VLAN

VLAN Mode Configuration

VLAN Mode
 Management VLAN

Port VLAN Configuration

Port No	Mode	Port VLAN	Tagged VLAN (Tagged)	Fixed VLAN (Untagged)
1	Access	1		
2	Access	1		
3	Access	1		
4	Access	1		

Save

VLAN Configuration

ENABLE VLAN

- : VLAN is enabled
- : VLAN is disabled

VLAN Mode Configuration

VLAN MODE

A drop-down menu will allow the user to select a VLAN mode:

- 802.1Q VLAN: Virtual Local Area Networks (VLANs) separate an existing physical network into multiple logical networks. Thus, each VLAN creates its own broadcast domain. Communication between two VLANs can only occur through a router that is connected to both. VLANs work as though they are created using independent switches.

When VLAN mode is set to 802.1Q VLAN and Ring mode is enabled, port 1-4 can be configured and the VLAN configuration page will be displayed as;

VLAN Configuration

Enable VLAN

VLAN Mode Configuration

VLAN Mode
 Management VLAN

Port VLAN Configuration

Port No	Mode	Port VLAN	Tagged VLAN (Tagged)	Fixed VLAN (Untagged)
1	Hybrid	1		
2	Access	1		
3	Access	1		
4	Access	1		

Save

When Ring mode is disabled, ports 5 and 6 can also be configured and the VLAN configuration page will be displayed as;

VLAN Configuration

Enable VLAN

VLAN Mode Configuration

VLAN Mode 802.1Q VLAN
 Management VLAN 1

Port VLAN Configuration

Port No	Mode	Port VLAN	Tagged VLAN (Tagged)	Fixed VLAN (Untagged)
1	Access	1		
2	Access	1		
3	Access	1		
4	Access	1		
5	Access	1		
6	Access	1		

Save

- **Port-Based VLAN:** A port-based VLAN configuration assign ports on the switch to a VLAN. The number of VLANs is limited to the number of ports on the switch. In a basic port-based VLAN configuration, ports with the same VLAN ID are placed into the same VLAN. One port can be a member of multiple VLANs. By Default, all the ports belong to group 1. Only ports assigned to group 1 can access the WebGUI.

When Ring mode is enabled port 1-4 can be configured.

VLAN Configuration

Enable VLAN

VLAN Mode Configuration

VLAN Mode Port-based VLAN

Port VLAN Configuration

Group ID	Port Members			
	1	2	3	4
1	<input checked="" type="checkbox"/>	<input checked="" type="checkbox"/>	<input checked="" type="checkbox"/>	<input checked="" type="checkbox"/>
2	<input type="checkbox"/>	<input type="checkbox"/>	<input type="checkbox"/>	<input type="checkbox"/>
3	<input type="checkbox"/>	<input type="checkbox"/>	<input type="checkbox"/>	<input type="checkbox"/>
4	<input type="checkbox"/>	<input type="checkbox"/>	<input type="checkbox"/>	<input type="checkbox"/>

Save

When Ring mode is disabled, ports 5 and 6 can also be configured.

VLAN Configuration

Enable VLAN

VLAN Mode Configuration

VLAN Mode Port-based VLAN

Port VLAN Configuration

Group ID	Port Members					
	1	2	3	4	5	6
1	<input checked="" type="checkbox"/>	<input checked="" type="checkbox"/>	<input checked="" type="checkbox"/>	<input checked="" type="checkbox"/>	<input checked="" type="checkbox"/>	<input checked="" type="checkbox"/>
2	<input type="checkbox"/>	<input type="checkbox"/>	<input type="checkbox"/>	<input type="checkbox"/>	<input type="checkbox"/>	<input type="checkbox"/>
3	<input type="checkbox"/>	<input type="checkbox"/>	<input type="checkbox"/>	<input type="checkbox"/>	<input type="checkbox"/>	<input type="checkbox"/>
4	<input type="checkbox"/>	<input type="checkbox"/>	<input type="checkbox"/>	<input type="checkbox"/>	<input type="checkbox"/>	<input type="checkbox"/>
5	<input type="checkbox"/>	<input type="checkbox"/>	<input type="checkbox"/>	<input type="checkbox"/>	<input type="checkbox"/>	<input type="checkbox"/>
6	<input type="checkbox"/>	<input type="checkbox"/>	<input type="checkbox"/>	<input type="checkbox"/>	<input type="checkbox"/>	<input type="checkbox"/>

Save

MANAGEMENT VLAN

The VLAN associated with the IP interface. Only ports in this VLAN will be able to access the IP interface.

Port VLAN Configuration

PORT NO

Displays port number per row

MODE

A drop-down menu allows user settings for the following;

- **Access:** Access ports are normally used to connect to end stations. Dynamic features like Voice VLAN may add the port to more VLANs behind the scenes. Access ports have the following characteristics:
 - Member of exactly one VLAN, the Port VLAN (a.k.a. Access VLAN), which by default is 1
 - Accepts untagged frames
 - Discards all frames not classified to the Access VLAN
 - On egress all frames are transmitted untagged
- **Trunk:** Trunk ports can carry traffic on multiple VLANs simultaneously, and are normally used to connect to other switches. Trunk ports have the following characteristics:
The VLANs that a trunk port is member of may be limited by the use of Allowed VLANs
 - Frames classified to a VLAN that the port is not a member of are discarded
 - By default, all frames but frames classified to the Port VLAN (a.k.a. Native VLAN) get tagged on egress. Frames classified to the Port VLAN do not get C-tagged on egress
 - Egress tagging can be changed to tag all frames, in which case only tagged frames are accepted on ingress
- **Hybrid:** Hybrid ports resemble trunk ports in many ways, but adds additional port configuration features. In addition to the characteristics described for trunk ports, hybrid ports have these abilities:
 - Can be configured to be VLAN tag unaware
 - Ingress filtering can be controlled
 - Ingress acceptance of frames and configuration of egress tagging can be configured independently

PORT VLAN

Determines the port's VLAN ID (a.k.a. PVID). Allowed VLANs are in the range 1 through 4095, default being 1.

On ingress, frames get classified to the Port VLAN if the port is configured as VLAN unaware, the frame is untagged, or VLAN awareness is enabled on the port, but the frame is priority tagged (VLAN ID = 0).

On egress, frames classified to the Port VLAN do not get tagged if Egress Tagging configuration is set to untag Port VLAN.

The Port VLAN is called an "Access VLAN" for ports in Access mode and Native VLAN for ports in Trunk or Hybrid mode.

TAGGED VLAN (TAGGED)

Ports in Trunk and Hybrid mode may control which VLANs they are allowed to become members of. Access ports can only be member of one VLAN, the Access VLAN.

The field's syntax is identical to the syntax used in the Enabled VLANs field. All VLAN frames in field(except port VLAN), are transmitted with a tag.

FIXED VLAN (UNTAGGED)

All VLAN frames in this field, are transmitted without a tag. This option is only available for ports in Hybrid mode.

Buttons

: saves the new settings

CONFIGURATION → PORT SETTING

Port Setting

Port	Mode
Port 1	Auto
Port 2	Auto
Port 3	Auto
Port 4	Auto
Port 5	Enable
Port 6	Enable

Save

PORT

Indicates port number per row.

MODE

Auto
10Mbps HDX
10Mbps FDX
100Mbps HDX
100Mbps FDX
1G FDX
Disable

Allows the user to manually set the port speed and duplex mode for the desired port.

- Auto: Auto Detect
- 10Mbps HDX: Half Duplex
- 10Mbps FDX: Full Duplex
- 100Mbps HDX: Half Duplex
- 100Mbps FDX: Full Duplex
- 1G FDX: Full Duplex
- Disable: Port Disable

Note: Port 1 to 4 are speed and full/half duplex selectable. Port 5 & 6 are enable/disable only.

Buttons

Save : saves the new settings

CONFIGURATION → LOG

Log Settings

ID	Module	Log Level
1	PoE	Info <input type="button" value="v"/>
2	SYS	Info <input type="button" value="v"/>

Setup log activity

ID

Indicates port number per row.

MODULE

System Type

LOG LEVEL

Allows the user to manually set the Log Level to be monitored

- Disable: Disables the log monitoring for selected port
- Info: Displays basic log activity for selected port
- Debug: Displays detailed log activity for selected port

Buttons

: saves the new settings

CONFIGURATION → IGMP

IGMP Snooping Configuration

IGMP Snooping	Disable ▾
Unregistered Multicast Flooding	Enable ▾

Port Related Configuration

Port	Static Router Port
1	Disable ▾
2	Disable ▾
3	Disable ▾
4	Disable ▾
5	Disable ▾
6	Disable ▾

Save

IGMP Snooping Configuration

IGMP SNOOPING

A drop down menu allows user settings for the following;

- Enable: Enables IGMP Snooping
- Disable: Disables IGMP Snooping

UNREGISTERED MULTICAST FLOODING

A drop down menu allows user settings for the following;

- Enable: Enables Unregistered Multicast Flooding. The unregistered IPMCv4 traffic will be forwarded to all other ports as broadcast traffic
- Disable: Disables Unregistered Multicast Flooding. The unregistered IPMCv4 traffic will not be received on other ports when IGMP function is enabled

Port Related Configuration

PORT

Displays port number per row

STATIC ROUTER PORT

A drop-down menu allows user settings for the following;

- Enable: Enables IGMP Static Router setting
- Disable: Disables IGMP Static Router setting

Buttons

Save: saves the new settings

CONFIGURATION → IGMP VLAN

IGMP Snooping VLAN Configuration

Delete	VLAN ID	Snooping Enabled	Router Port Aging Time	IGMP Version
<input type="checkbox"/>	10	<input checked="" type="checkbox"/>	150	Auto
<input type="checkbox"/>	11	<input checked="" type="checkbox"/>	150	Auto

Auto
 IGMP VER1
 IGMP VER2
 IGMP VER3

Displays up to 10 entries from the IGMP Snooping VLAN table. The maximum number of entries is 10.

DELETE

Deletes selected VLAN IDs during the next save function.

VLAN ID

Displays VLAN IDs.

An empty VLAN ID allows the user to enter a new VLAN ID

SNOOPING ENABLED

: Enables the per-VLAN IGMP snooping. Up to 10 VLANs can be selected

: Disables the per-VLAN IGMP snooping.

ROUTER PORT AGING TIME

Displays Router Port Aging Time (seconds) timeout if the querier packet is not received. User can set this time per VLAN ID. Integer value is between 1 and 31744. Default value is 150

IGMP VERSION

Displays the IGMP version. IGMP version is maintained by hosts and routers taking appropriate actions depending on the versions of IGMP operating on hosts and routers within a network.

The allowed selection from the drop-down menu is;

- Auto
- Forced IGMPv1
- Forced IGMPv2
- Forced IGMPv3

The default IGMP version value is IGMP-Auto

Buttons

: Click to add new IGMP VLAN.

: saves the new settings

CONFIGURATION → PoE

PoE Configuration

Port	Enable	Operating Mode	Legacy	Pair	Maximum Power	High Inrush Current Mode
1	<input checked="" type="checkbox"/>	<input checked="" type="radio"/> BT <input type="radio"/> PoH <input type="radio"/> Pre-BT <input type="radio"/> Mode 4P CDP <input type="radio"/> BT Special <input type="radio"/> BT Class0=Class4 <input type="radio"/> 2P 3Finger <input type="radio"/> 4P 4Finger <input type="radio"/> BT with PoH <input type="radio"/> BT PoH Like on Class <input type="radio"/> BT Special Class 4	<input checked="" type="radio"/> Disable <input type="radio"/> Enable	<input type="radio"/> 2 <input checked="" type="radio"/> 4	<input checked="" type="radio"/> 90 <input type="radio"/> 60 <input type="radio"/> 30 <input type="radio"/> 15	<input type="checkbox"/>
2	<input checked="" type="checkbox"/>	<input checked="" type="radio"/> BT <input type="radio"/> PoH <input type="radio"/> Pre-BT <input type="radio"/> Mode 4P CDP <input type="radio"/> BT Special <input type="radio"/> BT Class0=Class4 <input type="radio"/> 2P 3Finger <input type="radio"/> 4P 4Finger <input type="radio"/> BT with PoH <input type="radio"/> BT PoH Like on Class <input type="radio"/> BT Special Class 4	<input checked="" type="radio"/> Disable <input type="radio"/> Enable	<input type="radio"/> 2 <input checked="" type="radio"/> 4	<input checked="" type="radio"/> 90 <input type="radio"/> 60 <input type="radio"/> 30 <input type="radio"/> 15	<input type="checkbox"/>
3	<input checked="" type="checkbox"/>	<input checked="" type="radio"/> BT <input type="radio"/> PoH <input type="radio"/> Pre-BT <input type="radio"/> Mode 4P CDP <input type="radio"/> BT Special <input type="radio"/> BT Class0=Class4 <input type="radio"/> 2P 3Finger <input type="radio"/> 4P 4Finger <input type="radio"/> BT with PoH <input type="radio"/> BT PoH Like on Class <input type="radio"/> BT Special Class 4	<input checked="" type="radio"/> Disable <input type="radio"/> Enable	<input type="radio"/> 2 <input checked="" type="radio"/> 4	<input checked="" type="radio"/> 90 <input type="radio"/> 60 <input type="radio"/> 30 <input type="radio"/> 15	<input type="checkbox"/>
4	<input checked="" type="checkbox"/>	<input checked="" type="radio"/> BT <input type="radio"/> PoH <input type="radio"/> Pre-BT <input type="radio"/> Mode 4P CDP <input type="radio"/> BT Special <input type="radio"/> BT Class0=Class4 <input type="radio"/> 2P 3Finger <input type="radio"/> 4P 4Finger <input type="radio"/> BT with PoH <input type="radio"/> BT PoH Like on Class <input type="radio"/> BT Special Class 4	<input checked="" type="radio"/> Disable <input type="radio"/> Enable	<input type="radio"/> 2 <input checked="" type="radio"/> 4	<input checked="" type="radio"/> 90 <input type="radio"/> 60 <input type="radio"/> 30 <input type="radio"/> 15	<input type="checkbox"/>

Save Reset

PORT

Indicates port number per row.

POE ENABLED

A tick indicates the PoE is enabled for the port.

OPERATING MODE

A highlighted button indicates PoE mode selected.

LEGACY

A highlighted button indicates Legacy mode selected.

PAIR

A highlighted button indicates Pair mode selected.

MAXIMUM POWER

A highlighted button indicates maximum Power mode selected per port.

HIGH INRUSH CURRENT MODE

A highlighted button enables High Inrush Current mode.

Buttons

: saves the new settings

CONFIGURATION → PORT SECURITY

Port Security Configuration

Port	Mode
1	Disable ▾
2	Disable ▾
3	Disable ▾
4	Disable ▾
5	Disable ▾
6	Disable ▾

PORT

Indicates port number per row.

MODE

A drop-down menu allows user settings for the following;

- Enable: Enables port security for selected port number
- Disable: Disables port security for selected port number

Buttons

: saves the new settings

CONFIGURATION → PORT SECURITY MAC

Port Security Static MAC Address

Delete	Port	VLAN ID	MAC Address
<input type="checkbox"/>	1 ▾	1	00:26:dc:12:34:57
<input type="checkbox"/>	1 ▾	1	00:26:dc:12:34:59
<input type="checkbox"/>	1 ▾	1	00:26:dc:12:34:5a
<input type="checkbox"/>	1 ▾	1	00:26:dc:12:34:5b
<input type="checkbox"/>	1 ▾	1	00:26:dc:12:34:5c
<input type="checkbox"/>	1 ▾	1	00:26:dc:12:34:5d
<input type="checkbox"/>	1 ▾	1	00:26:dc:12:34:5e
<input type="checkbox"/>	1 ▾	1	00:26:dc:12:34:5f
<input type="checkbox"/>	1 ▾	123	00:00:00:00:00:00
<input type="checkbox"/>	2 ▾	1	00:26:dc:12:34:56
<input type="checkbox"/>	2 ▾	1	00:26:dc:12:34:64
<input type="checkbox"/>	2 ▾	2	00:26:dc:12:34:57
<input type="checkbox"/>	3 ▾	1	00:26:dc:12:34:63
<input type="checkbox"/>	4 ▾	1	00:26:dc:12:34:62
<input type="checkbox"/>	5 ▾	1	00:26:dc:12:34:61
<input type="checkbox"/>	6 ▾	1	00:26:dc:12:34:60
Delete	1 ▾	1	00:00:00:00:00:00

Add

Save

DELETE

Deletes selected VLAN IDs during the next save function.

PORT

Select the port number from the drop-down menu

VLAN ID

Displays VLAN IDs.

An empty VLAN ID allows the user to enter a new VLAN ID

Valid VLAN IDs 1-4094

MAC ADDRESS

Source MAC Address. The address must contain 12 hexadecimal digits, optionally separated in groups of two digits by either ':', '-' or '.'.

The same MAC address can be configured in different VLAN. The same MAC address can not be configured on a different port with the same VLAN.

Duplicated MAC addresses will be removed while saving the configuration.

Special MAC addresses will not be accepted.

Ensure valid MAC entry (eg:-not multicast MAC)

Notes;

A maximum of 30 entries can be added into the table.

When adding the same MAC address into the same VLAN, the duplicated entry will be automatically deleted.

Buttons

Add: click to add new entry.

Save: saves the new settings

MONITOR → SYSTEM INFO

Software Information

Parameter	Value
Software ID	600173-01
Build Time	28-09-2023:11:02:17

Hardware Information

Parameter	Value
MAC Address	00-26-dc-00-22-84
Serial Number	00000000
PCB Number	ffff-ff
Date of Manufacture (DD-MM-YYYY)	20-09-2023

Running Information

Parameter	Value
Running Hours	0 D: 0 H : 39 M : 50 S
Location	Not set
IP Address	192.168.0.99
Subnet Mask	255.255.255.0
Default Gateway	192.168.0.1
Temperature	43°C
DIP Switch	1-0-0-0-0-0-X

This menu is identical to the start-up menu. A table displaying useful system information is also displayed containing MAC address, Serial Number, Software, IP address, etc.

MONITOR → PORT

Port Status

Port	Copper/SFP	Role	Link	Speed	Duplex
1	Copper	Switch Port	Down	-	-
2	Copper	Switch Port	Up	1000	Full
3	Copper	Switch Port	Down	-	-
4	Copper	Switch Port	Down	-	-
5	SFP	Ring Port	Down	-	-
6	SFP	Ring Port	Down	-	-

PORT

Monitors each port activity.

COPPER/SFP

Indicates the port connection: Either Copper or SFP

ROLE

Indicates the role of each ports connections: Switch Port, Ring Port, Bus Port.

LINK

Up: Connection established
Down: No Connection detected

SPEED

Indicates the port connection speed in Mbps.

- **10:** 10Mbps
- **100:** 100Mbps
- **1000:** 1000Mbps (1Gbps)

DUPLEX

Indicates port connection type. Full, Half

MONITOR → TOPOLOGY

Ring Topology Status

No	MAC Address	Topology	Node Role	Ring_P0	Ring_P1	IP Address	Ring Version	Device	Location
1	00-26-dc-00-42-39	INIT	SLAVE	U_port	U_port	192.168.16.27	9	OSD2251EP	Not set

Shows the topology map of available devices in the connected ring/bus.

No

Unit number within the connected ring/bus

MAC ADDRESS

Displays the MAC address number for each unit connected on the ring/bus

TOPOLOGY

Indicates the topology type;

- **INIT**: Waiting for ring protocol communication from neighbouring node
- **BUS**: BUS mode when system discovers bus topology
- **RING**: Ring mode when system discovers ring topology
- **UNKNOWN**: Unknown state

NODE ROLE

Indicates whether the unit is either the Master or Slave on the ring/bus. The Master is determined by the lowest MAC address

RING_P0

Indicates the function of Port 5 and its relation to the ring/bus

- **M_Port**: Master Port (Port facing the master)
- **S_Port**: Slave Port (Port back to the master)
- **B_Port**: Backup Port
- **U_Port**: Unconnected Port

RING_P1

Indicates the function of Port 6 and its relation to the ring/bus

- **M_Port**: Master Port (Port facing the master)
- **S_Port**: Slave Port (Port back to the master)
- **B_Port**: Backup Port
- **U_Port**: Unconnected Port

IP ADDRESS

Displays the IP address for each unit connected on the ring/bus

RING VERSION

Indicates the ring module software version

DEVICE

Indicates the OSD product within the ring

LOCATION

The location of the device can be set and displayed in this window

MONITOR → PoE

PoE Port Status

Auto-refresh Refresh

PortNo	PDType	Current	Voltage	Power Requested	Power Assigned	Class on AlternativeA	Class On AlternativeB	Status
1	-	-	-	-	-	-	-	Not connected
2	-	-	-	-	-	-	-	Not connected
3	-	-	-	-	-	-	-	Not connected
4	-	-	-	-	-	-	-	Power off: Unknown

Global Status

Parameter	Value
PoE Output Voltage	54.4V
PoE Manager Temperature	37°C
PoE Controller Software Version	3.5.4

PORT

Indicates port number per row.

PD TYPE

Indicates the PD channel type connected to the port

CURRENT

Indicates the current drawn from the relevant PoE port/channel

VOLTAGE

Indicates the voltage from the relevant PoE port/channel

POWER REQUESTED

Indicates the power drawn from the relevant PoE port/channel

POWER ASSIGNED

Indicates the power provided from the relevant PoE port/channel

CLASS ON ALTERNATIVE A

Indicates the class type from the relevant PoE port/channel

CLASS ON ALTERNATIVE B

Indicates the class type from the relevant PoE port/channel

STATUS

Indicates the status of the port

MONITOR → SYSTEM LOG

System Log Information

ID	Time	Logs
7	0 D: 0 H: 0 M: 0 S	Port 2 link up.
6	0 D: 0 H: 0 M: 0 S	Device boot up(0).
5	0 D: 0 H: 0 M: 0 S	Port 2 link up.
4	0 D: 0 H: 0 M: 0 S	Device boot up(0).
3	0 D: 0 H: 0 M: 0 S	Device boot up(0).
2	0 D: 0 H: 0 M: 0 S	Device boot up(0).
1	0 D: 0 H: 0 M: 0 S	Software upgrade success.

Monitors and logs activity

ID

Event number

TIME

Records a time-stamp of the log activity

LOG

A brief description of the type of event

MONITOR → IGMP

IGMP Snooping Status

VLAN	Queries Version	Host Version	Queries Received	V1 Reports Received	V2 Reports Received	V3 Reports Received	Leaves Received
------	-----------------	--------------	------------------	---------------------	---------------------	---------------------	-----------------

Router Port Status

Port	Status
1	-
2	-
3	-
4	-
5	-
6	-

Group Information

VLANs	Groups	Port Members
-------	--------	--------------

IGMP Snooping Status

VLAN

Indicates the VLAN address of device being monitored

QUERIES VERSION

Working Querier version of IGMP operating on current hosts.

HOST VERSION

Working version of IGMP operating on current hosts.

QUERIES RECEIVED

Indicates the IGMP Snooping queries the particular VLAN address has received

V1 REPORTS RECEIVED

Indicates the IGMP Snooping reports the particular VLAN address has received

V2 REPORTS RECEIVED

Indicates the IGMP Snooping reports the particular VLAN address has received

V3 REPORTS RECEIVED

Indicates the IGMP Snooping reports the particular VLAN address has received

LEAVES RECEIVED

Indicates the IGMP Snooping leaves the particular VLAN address has received

Router Port Status

PORT

Lists the port number of devices being monitored to display status

STATUS

Indicates the status of the router port number

Group Information

VLANs

VLAN ID of the group.

GROUP

Group address of the group displayed.

PORT MEMBERS

Ports under this group.

MAINTENANCE → UPLOAD

Software Upload

No file selected.

Use this section to upload OSD released update software.

Click the button and navigate to the folder where the software is saved then select the file.

Click the button to start the upload process.

After the software has been updated, the unit will restart.

It is advised to check that the unit has the uploaded software installed correctly by selecting Monitor → System Info. Check the Software ID and the Build Time (date and time of upload) is correct.

Software Information

Parameter	Value
Software ID	600136-05
Build Time	14-07-2020:11:00:15

Buttons

: Browse file location

: Upload software

MAINTENANCE → PoE FW UPGRADE

PoE chip(PD69200) Firmware Upgrade

No file selected.

Use this section to upload OSD released firmware update.

Click the Browse (or Choose File) button and navigate to the folder where the updated firmware has been saved. Select the firmware file.

Click the Upload button. The firmware will be uploaded to the unit. Please wait until firmware has been uploaded completely as shown below and wait until the system has rebooted.

MAINTENANCE → SECURITY

Security

Change Login Details	
Current Username	admin
Current Password	
New Username	admin
New Password	
Confirm Password	

Use this section to change user name and passwords

CURRENT USERNAME

Displays the current or default user name for the unit. *Default username is "admin"*

CURRENT PASSWORD

Enter the current password in order to change username or password. *Default password is left blank for user to select when setting up the unit. For user security, it is highly advised to set passwords!*

NEW USERNAME

Enter new username in this window. The allowed string length is 1 to 8.

NEW PASSWORD

Enter new password in this window. The allowed string length is 0 to 24. Any printable characters including space is accepted

CONFIRM PASSWORD

Enter new password again in this window. This window must match new password window in order for new password to take effect.

Buttons

: click save for new username and/or password settings to take effect.

MAINTENANCE → FACTORY DEFAULT

Factory Defaults

[Default Settings](#)

Clicking this button will reset the unit to factory default settings including the user name and current password.

MAINTENANCE → SYSTEM REBOOT

System Reboot

[Reboot](#)

Use the section to reboot the system when any switch settings are changes for the new settings to take effect.

4 MAINTENANCE

4.1 INTRODUCTION

The following section outlines the fault-finding procedure for the OSD2284P modems. Please take note of the following:

- ▲ Personnel without appropriate training should not attempt any maintenance except that outlined below.
- ▲ If further maintenance is attempted you are warned that every care should be taken to ensure that internal measurements made while the equipment is operational are taken carefully as some components within the unit are expensive and may be damaged by failure of any portion of their support circuitry.
- ▲ Some components within the unit are Electrostatic (ES) sensitive and Electrostatic Discharge (ESD) precautions should be taken when performing maintenance upon the unit.

4.2 EXTERNAL INSPECTION

Visually check for the following:

- ▲ Check that the correct power source is connected to the power socket.
- ▲ Check that the Ethernet cables are connected to the modem correctly and that the distant OSD2284P modem has been connected correctly to any external equipment.
- ▲ Inspect the optical connectors (for fiber SFP option) for any contamination and clean using isopropyl alcohol and a lint free tissue if any contamination is detected.

4.3 ROUTINE MAINTENANCE

- ▲ There is no routine maintenance required with the OSD2284P.

5 WARRANTY

Thank you for purchasing equipment designed, manufactured and serviced by Optical Systems Design (OSD). OSD warrants that at the time of shipment, its products are free from defects in material and workmanship and conforms to specifications. Our Warranty conditions are outlined below:

5.1 WARRANTY PERIOD

For warranty period, please contact your local OSD distributor.

5.2 REPAIRS

Optical Systems Design reserves the right to repair or replace faulty modules/units. Please obtain a "Return Material Authorisation" (RMA) form and number before returning goods. Goods must be returned in adequate packing material to Optical Systems Design, Warriewood or its nominated authorised representative, for all repairs.

5.2.1 WARRANTY REPAIRS

Return shipments to OSD shall be at customer's expense and freight back to the customer will be at OSD expense.

5.2.2 OUT-OF-WARRANTY REPAIRS

OSD reserves the right to repair or replace any faulty goods. Freight costs and insurance for both journeys are met by the user. All equipment repaired by OSD will have a 3-Month Warranty from the date of dispatch.

5.2.3 SITE REPAIRS

By agreement site repairs may be undertaken for which out of pocket, hotel and travel expenses will be charged.

5.2.4 EXCLUSIONS

This warranty does not apply to defects caused by unauthorized modifications, misuse, abuse or transport damage to the equipment. All modifications to OSD's standard product will need written authorization and will be charged at normal repair rates. All modifications are to be carried out by OSD Technicians. Warranty is void if unauthorized removal and/or tampering with serial number and/or repair labels is evident.



Optical Systems Design Pty. Ltd.
7/1 Vuko Pl. Warriewood 2102
P.O. Box 891 Mona Vale
N.S.W. Australia 2103
Telephone: +61 2 9913 8540
Facsimile: +61 2 9913 8735
Email: sales@osd.com.au
Web Site: www.osd.com.au