OPTICAL

SYSTEMS

DESIGN

OPERATOR MANUAL

OSD2254P SERIES

6-PORT REDUNDANT RING

**GIGABIT ETHERNET SWITCH WITH
PoE++ SOURCE**

OPTICAL SYSTEMS DESIGN

INDEX 1

| | | |
|----------|---|-----------|
| 1 | TECHNICAL SUMMARY | 5 |
| 1.1 | BRIEF DESCRIPTION | 5 |
| 1.1.1 | OVERVIEW..... | 5 |
| 1.1.2 | APPLICATIONS..... | 6 |
| 1.1.3 | FEATURES AND BENEFITS..... | 6 |
| 1.2 | TECHNICAL SPECIFICATIONS | 7 |
| 1.3 | OSD2254P PORT ALLOCATION..... | 8 |
| 2 | INSTALLATION AND OPERATION | 9 |
| 2.1 | INTRODUCTION | 9 |
| 2.2 | INSTALLATION | 9 |
| 2.2.1 | WARNING AND PRECAUTIONS..... | 9 |
| 2.2.2 | OSD2254P DRAWINGS AND DIMENSIONS | 10 |
| 2.2.3 | LOCATION | 11 |
| 2.2.4 | POWER SUPPLY CONNECTIONS | 11 |
| 2.2.5 | OSD2254P ALARM CONNECTION..... | 12 |
| 2.2.6 | USB CONNECTOR..... | 13 |
| 2.2.7 | LED INDICATORS | 15 |
| 2.2.8 | CONTROLS..... | 16 |
| 2.2.9 | FITTING SFP CONNECTORS | 17 |
| 2.3 | OSD2254P OPERATION..... | 18 |
| 2.3.1 | CONNECTIONS..... | 18 |
| 2.4 | TYPE-A USB PORT..... | 20 |
| 2.5 | COMMAND LINE INTERFACE | 21 |
| 2.5.1 | TERMINAL EMULATION SETUP | 21 |
| 2.5.2 | COMMAND LINE FUNCTIONS | 22 |
| 3 | MAINTENANCE | 27 |
| 3.1 | INTRODUCTION | 27 |
| 3.2 | EXTERNAL INSPECTION | 27 |
| 3.3 | ROUTINE MAINTENANCE..... | 27 |
| 4 | WARRANTY | 28 |
| 4.1 | WARRANTY PERIOD | 28 |
| 4.2 | REPAIRS..... | 28 |
| 4.2.1 | WARRANTY REPAIRS..... | 28 |
| 4.2.2 | OUT-OF-WARRANTY REPAIRS..... | 28 |
| 4.2.3 | SITE REPAIRS | 28 |
| 4.2.4 | EXCLUSIONS | 28 |
| | FIGURE 1: OSD2254P TYPICAL RING CONFIGURATION | 5 |
| | FIGURE 2: OSD2254P PORT ALLOCATION..... | 8 |
| | FIGURE 3: OSD2254P MOUNTING DIMENSIONS | 10 |
| | FIGURE 4: OSD2254P POWER SUPPLY CONNECTIONS..... | 11 |
| | FIGURE 5: ALARM OUTPUTS | 12 |
| | FIGURE 6: CONTACT CLOSURE OUTPUT | 12 |
| | FIGURE 7: USB TYPE B CLI PORT..... | 13 |
| | FIGURE 8: WIN XP INSTALLATION..... | 14 |
| | FIGURE 9: PORT/LED | 15 |
| | FIGURE 10: OSD2254P CONTROLS | 16 |
| | FIGURE 11: OSD2254P 8-WAY DIP SWITCH..... | 16 |
| | FIGURE 12: FITTING/REMOVING SFP CONNECTORS | 17 |
| | FIGURE 13: REDUNDANT RING CONFIGURATION | 18 |
| | FIGURE 14: REDUNDANT RING CONNECTION | 19 |
| | FIGURE 15: BUS CONNECTION..... | 19 |
| | FIGURE 16: OSD2254P MICRO USB CONNECTOR | 20 |
| | FIGURE 17: SERIAL PORT SETTINGS..... | 21 |

OPTICAL SYSTEMS DESIGN

| | |
|--|----|
| FIGURE 18: TOPOLOGY CHECK..... | 23 |
| FIGURE 19: TOPOLOGY CHECK..... | 24 |
| FIGURE 20: LOCAL NODE CHECK..... | 25 |
| FIGURE 21: VERSION CHECK..... | 26 |
| | |
| TABLE 1: TECHNICAL SPECIFICATIONS..... | 7 |
| TABLE 2: DC OR AC POWER CONNECTION..... | 11 |
| TABLE 3: ALARM CONNECTIONS..... | 12 |
| TABLE 4: LED FUNCTION..... | 15 |
| TABLE 5: OSD2254P 8-WAY DIP SWITCH SETTINGS..... | 16 |
| TABLE 6: CURRENT LIMITING SWITCH SETTINGS..... | 17 |
| TABLE 7: TERMINAL COMMAND LINES..... | 22 |

1 TECHNICAL SUMMARY

1.1 BRIEF DESCRIPTION

1.1.1 OVERVIEW

The OSD2254P is a 6-port industrial switch with redundant ring Gigabit Ethernet and PoE++ Source providing simple network management with real-time monitoring. It has four 10/100/1000Base-T RJ45 copper ports and two SFP ports for ring/bus configuration.

The OSD2254P incorporates redundant ring technology providing maximum reliability on critical networks. In the event of device or fiber failure the data path will automatically switch to a secondary path in less than 2ms per hop to maintain ring network integrity.

The OSD2254P has Power over Ethernet++ (PoE++) function and operates as a Power Source Equipment (PSE). The OSD2254P PoE++ can provide up to 60W to each RJ45 port to Powered Devices (PD). The unit will operate on either singlemode or multimode fiber. Operation over a network of hundreds of kilometers is possible by use of the appropriate optical devices. It normally requires two fibers but is optionally available for one fiber operation per port.

A major benefit of the OSD2254P is its reliable and consistent performance over the -20°C to +75°C temperature range that allows it to be used in uncontrolled environments such as roadside cabinets, mine sites and factories.

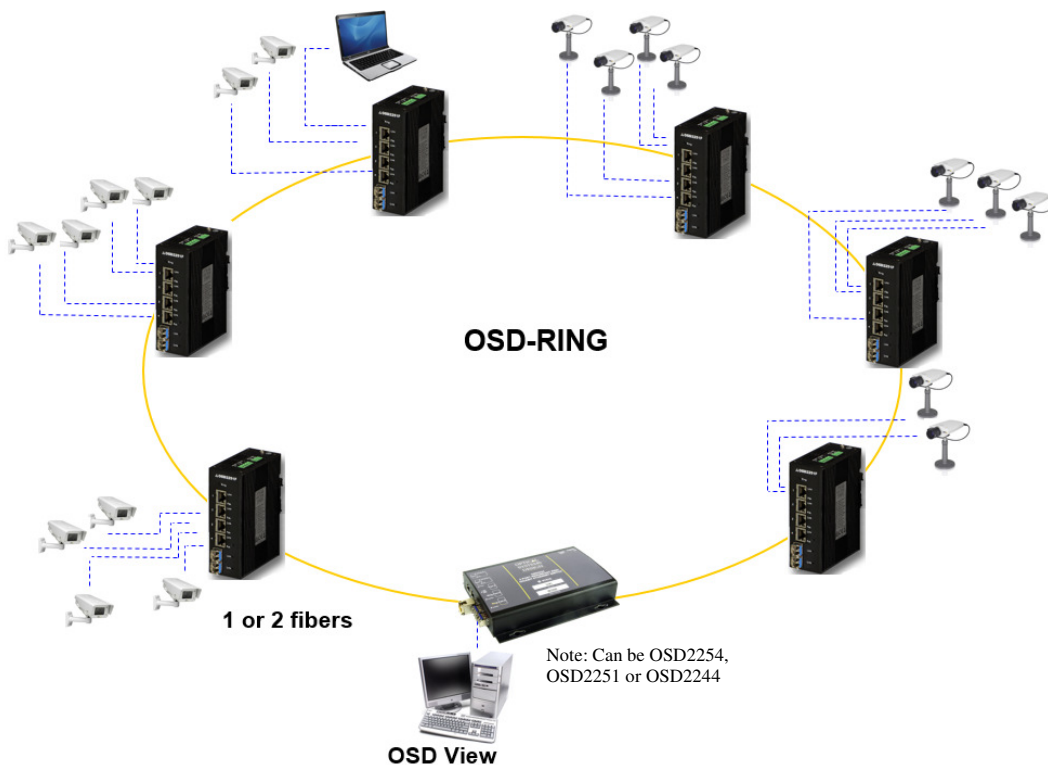

FIGURE 1: OSD2254P TYPICAL RING CONFIGURATION

OPTICAL SYSTEMS DESIGN

1.1.2 APPLICATIONS

- ▲ Any network utilising a mix of copper and fiber
- ▲ Industrial IP communications
- ▲ Self-healing Gigabit Ethernet backbone networks
- ▲ Networks using Power over Ethernet devices such as cameras, intercoms, access control, telephones, etc.

1.1.3 FEATURES AND BENEFITS

- ▲ Complies with IEEE802.3i/802.3u/802.3ab 10/100/1000Base-T, IEEE802.3u, 100Base-Fx, IEEE802.3z 1000Base-Lx/Sx standards
- ▲ Has a total of six ports: four fixed copper ports for 10/100/1000Base-T and two SFP ports for the fiber ring
- ▲ A network diameter of hundreds of kilometers is practical
- ▲ Ring reconfiguration in the case of cable or switch failures takes less than two milliseconds per hop
- ▲ MDI/MDIX Crossover: no need for crossover cables
- ▲ Supports IEEE802.3af/at Alternative B cable wiring
- ▲ Can be used with either singlemode or multimode fiber over a variety of link budgets
- ▲ Available for operation over 1 or 2 fibers
- ▲ Auto-Negotiation for half or full duplex operation
- ▲ Complies with the IEEE802.3af/at standard including compliant powered device (PD) signature detection and classification
- ▲ Provides up to 60W to each port
- ▲ Supports 10KB jumbo frames
- ▲ Powered by either one or two non-critical 46 to 57V_{DC} supplies
- ▲ Operates over the temperature range of -20°C to +75°C
- ▲ SFP module sold separately
- ▲ Compatible with the OSD2244 or OSD2251 Gigabit Ethernet Switches.
- ▲ OSDview Lite Network Management System
- ▲ DIN rail Mounting
- ▲ Available for operation in Ring or point-to-point configuration

OPTICAL SYSTEMS DESIGN

1.2 TECHNICAL SPECIFICATIONS

TABLE 1: TECHNICAL SPECIFICATIONS

| SPECIFICATION | PERFORMANCE |
|----------------------------|---|
| Electrical Data Interface | IEEE802.3i/802.3u/802.3ab/802.3af/802.3at, 10/100/1000Base-T Ethernet |
| Electrical Data Rate | 10, 100, 1000Mbps with energy detect, auto negotiate, auto MDIX |
| Jumbo Frame Support | 10KB |
| Optical Data Interface | IEEE802.3z 1000Base-Lx/Sx or IEEE802.3u 100Base-Fx |
| Optical Data Rate | 100Mbps or 1000Mbps user selectable |
| Operating Mode | Ring or non-ring user selectable Half or full duplex for 10/100 Full duplex for 1000 Pause frames for 1000Mbps flow control |
| Electrical Data Connectors | RJ45 |
| Alarms | Ring to Bus High Temperature |
| Alarm Interface | Optoisolated MOSFET rated at 100mA @ 46V maximum |
| PoE | IEEE802.3af, IEEE802.3at and PoE++ |
| Operating Mode | Alternative A & B (Pins 1/2, 3/6, 4/5 and 7/8) |
| Optical Port Connectors | SFP |
| SFP Options | Short haul, long haul, single fiber operation, etc. Please consult OSD DATASHEET #100210000x or contact OSD |
| Indicators | 4x Copper Link 4x Copper Activity 4x PoE Operation on RJ45s 2x SFP Speed/Activity/Link on SFPs 1x Power/temperature Alarm 1x Initialise/Ring/Bus |
| Dimensions (mm) | 43W x 91D x 130H |
| Weight | 0.58kg |
| Power Requirements | 46 to 57V _{DC} @ 1.5A maximum (attached powered device dependant) >52V _{DC} recommended for PoE+ or ≥55V _{DC} for 60W |
| Power Connector | 4 way 5.08mm terminal block |
| Alarm Connector | 4 way 3.5mm terminal block |
| Operating Temperature | -20°C to +75°C |
| Relative Humidity | 0 to 95% non-condensing |

1022254P02

OPTICAL SYSTEMS DESIGN

1.3 OSD2254P PORT ALLOCATION

Front Panel: There are four fixed copper ports for 10/100/1000Base-T and two SFP ports.

Top Panel: The top panel consists of a 4-way 5.08mm terminal block power connector and a 4way 3.5mm terminal block alarm connector.

Bottom Panel: 8-Way DIP switch, Micro USB connector and a Type-B USB connector.

Each section will be described further throughout this manual.

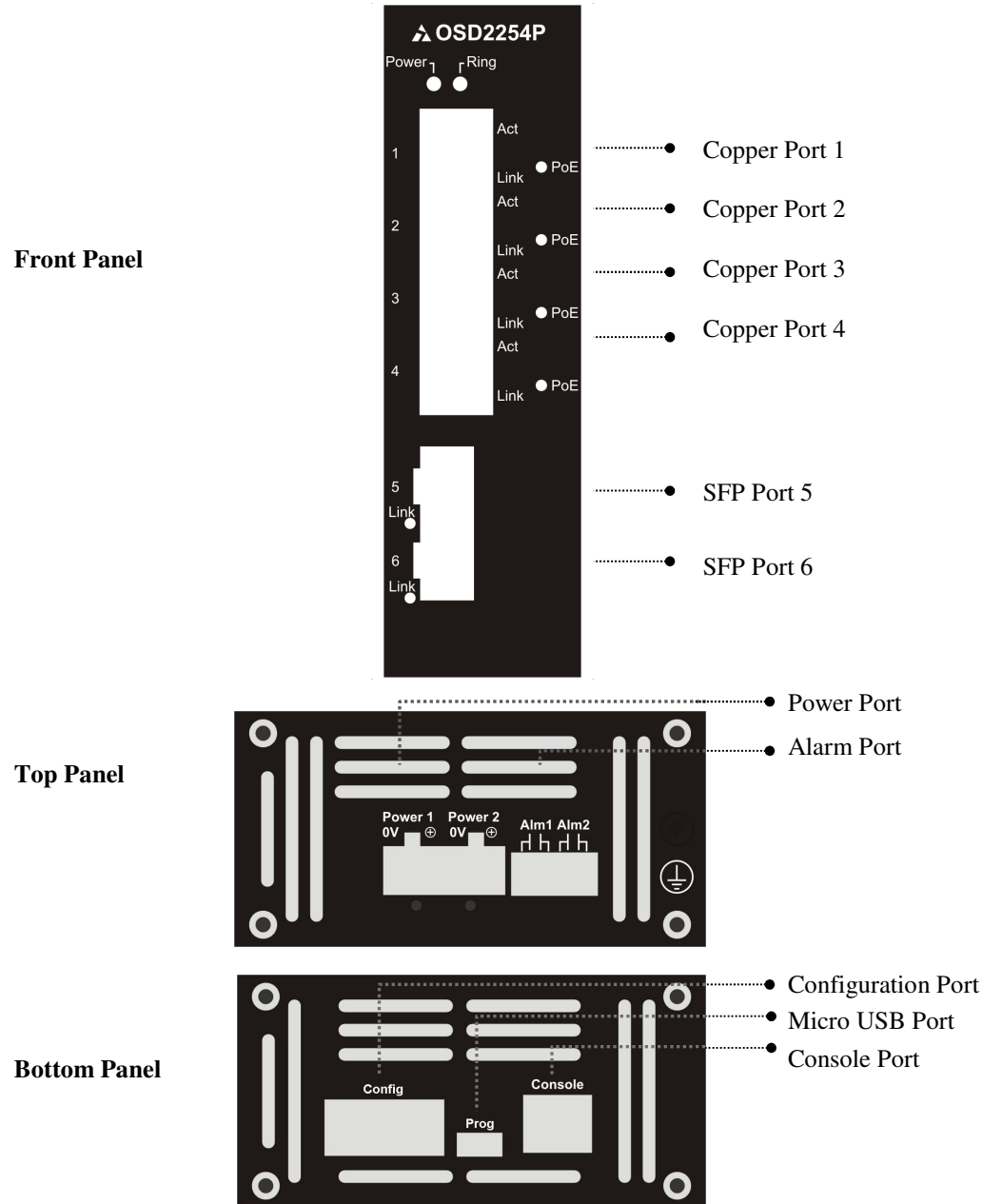

FIGURE 2: OSD2254P PORT ALLOCATION

2 INSTALLATION AND OPERATION

2.1 INTRODUCTION

This section outlines the methods required to install and operate the OSD2254P successfully. It should be studied carefully if damage to the equipment or poor results are to be avoided.

This equipment has been fully tested prior to dispatch and is ready for immediate operation. However it is advisable to check for external transportation damage before operation. If damage is evident, return the unit with the packaging to your supplier immediately.

2.2 INSTALLATION

2.2.1 WARNING AND PRECAUTIONS

▲ ELECTROMAGNETIC COMPATIBILITY

WARNING: This is a Class A product. In a domestic environment this product may cause radio interference in which case the user may be required to take adequate measures.

▲ OPTICAL OUTPUT OPERATION

WARNING: Laser Safety: Class 1 Laser Product per IEC/EN 60825-1:20011 standard.

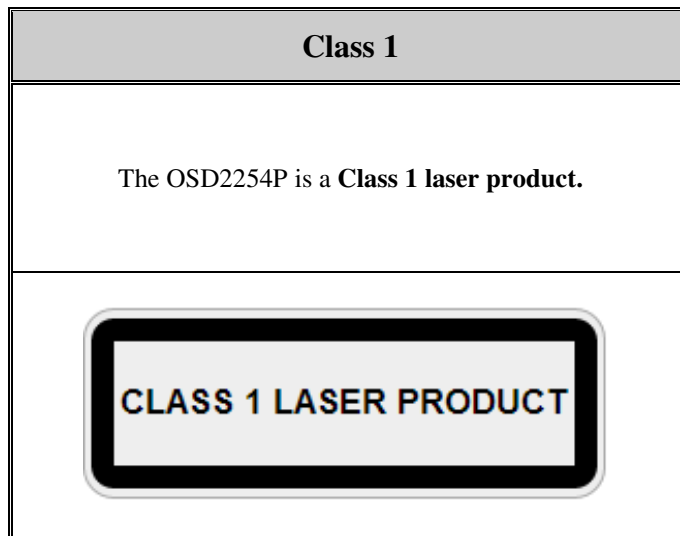

PRECAUTIONS

- ▲ All service personnel should be provided training as to the hazards of direct viewing of laser radiation and of the precautionary measures during servicing of equipment
- ▲ Areas where laser products are installed should be restricted in access to trained service personnel only and appropriate warning signs posted in the work area.
- ▲ All laser apertures should be covered by protective covers when not connected to optical fibers. Never leave outputs uncovered.
- ▲ Laser equipment should be positioned above or below eye level where possible. Apertures should be positioned away from personnel.
- ▲ Protective eyewear should be worn in the vicinity of laser equipment.

OPTICAL SYSTEMS DESIGN

2.2.2 OSD2254P DRAWINGS AND DIMENSIONS

The OSD2254P is designed to be wall mounted onto a DIN-Rail (35mm top hat) fixture. The unit dimensions (excluding connectors, SFPs, etc) is shown in Figure 3 below

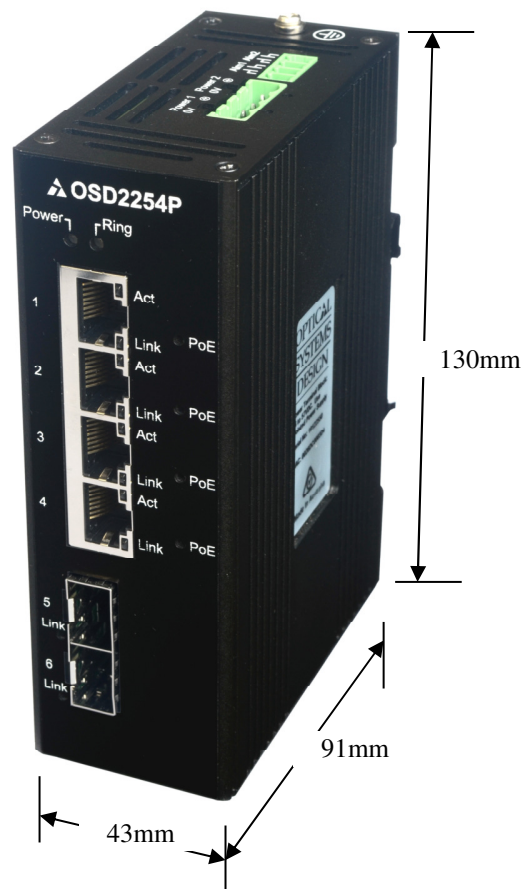

FIGURE 3: OSD2254P MOUNTING DIMENSIONS

OPTICAL SYSTEMS DESIGN

2.2.3 LOCATION

As with any electrical devices, the OSD2254P should be placed where it will not be subjected to extreme temperatures, humidity, or electromagnetic interference. Specifically, the site selected should meet the following requirements:

- The ambient temperature should be between -20°C to 75°C.
- The relative humidity should be less than 95 percent, non-condensing.
- Surrounding electrical devices should not exceed the electromagnetic field (RFC) standards.
- Make sure that the switch receives adequate ventilation. Do not block the ventilation holes on any side of the switch.

Note: Without proper cooling and control (lowering) of ambient temperature, the components within the OSD2254P can be subject to increased heat shortening the longevity and reliability. It is thus good engineering practice to ensure the unit is installed in a well ventilated area.

2.2.4 POWER SUPPLY CONNECTIONS

The OSD2254P requires external power to the Redundant DC Terminal Block Power Connector located at the top of the unit. Always ensure that the power is off before any installation.

Redundant DC Terminal Block Power Inputs

There are two pairs of power inputs for use with redundant power sources. Only one power input is required to be connected to run the switch.

Step 1: Connect the DC power to the appropriate power source, connect the plug-able terminal block on the OSD2254P switch and then turn power on.

Step 2: Disconnect the power if you want to shut down the switch.

TABLE 2: DC OR AC POWER CONNECTION

| External Power Pin | Specification |
|---|--|
| Power 1 + | 46V _{DC} to 57V _{DC} @ 1.5A* |
| Power 1 0V | Ground – 0V |
| Power 2 + | 46V _{DC} to 57V _{DC} @ 1.5A* |
| Power 2 0V | Ground – 0V |
|  | Earth Ground Connection |

*≥52V_{DC} recommended for PoE+ or ≥ 55V_{DC} for 60W PoE

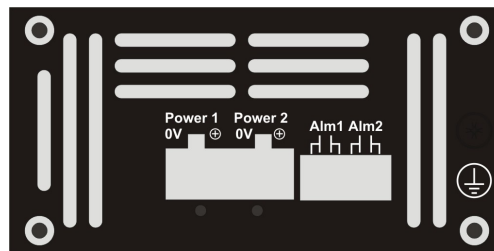

FIGURE 4: OSD2254P POWER SUPPLY CONNECTIONS

OPTICAL SYSTEMS DESIGN

2.2.5 OSD2254P ALARM CONNECTION

The OSD2254P has two monitoring alarm outputs: 1) Ring to Bus Alarm and 2) Temperature Alarm. The alarm connections and conditions for alarm outputs are as set out in Table 3. There are four pins on the 3.5mm terminal block used alarm output. Maximum ratings the OSD2254P relay can drive is 100mA @ 46V_(max). Note: Alarm output has no polarity.

TABLE 3: ALARM CONNECTIONS

| Alarm Output | Alarm1 Ring /Bus Status | Alarm CH2 Temperature |
|--------------|-------------------------|-----------------------|
| Open | Ring | Less than 90°C |
| Closed | Bus* | Higher than 90°C |

*Note: Bus alarm is only triggered *after* a ring connection is established.

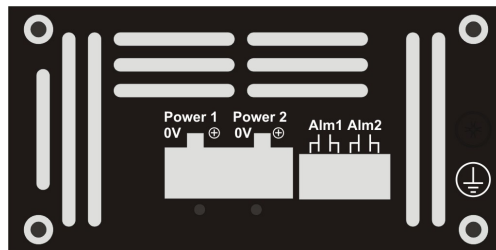

FIGURE 5: ALARM OUTPUTS

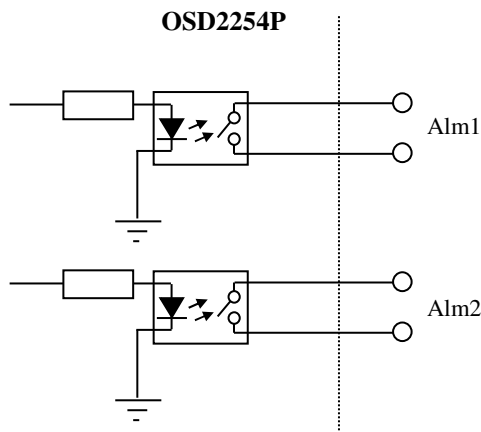

FIGURE 6: CONTACT CLOSURE OUTPUT

OPTICAL SYSTEMS DESIGN

2.2.6 USB CONNECTOR

The OSD2254P has a USB – Type B connector located on the bottom of the unit that is used for Command Line Interface (CLI) from the PC to the OSD2254P via the PC's USB connector. See section 2.5 for further CLI information.

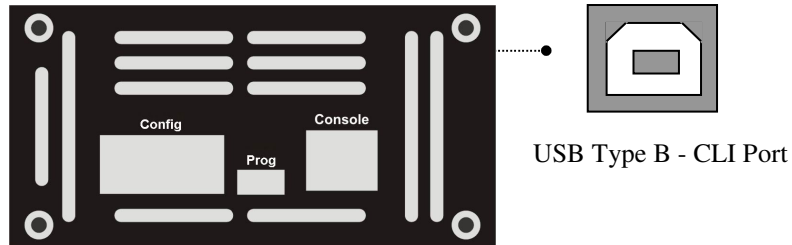
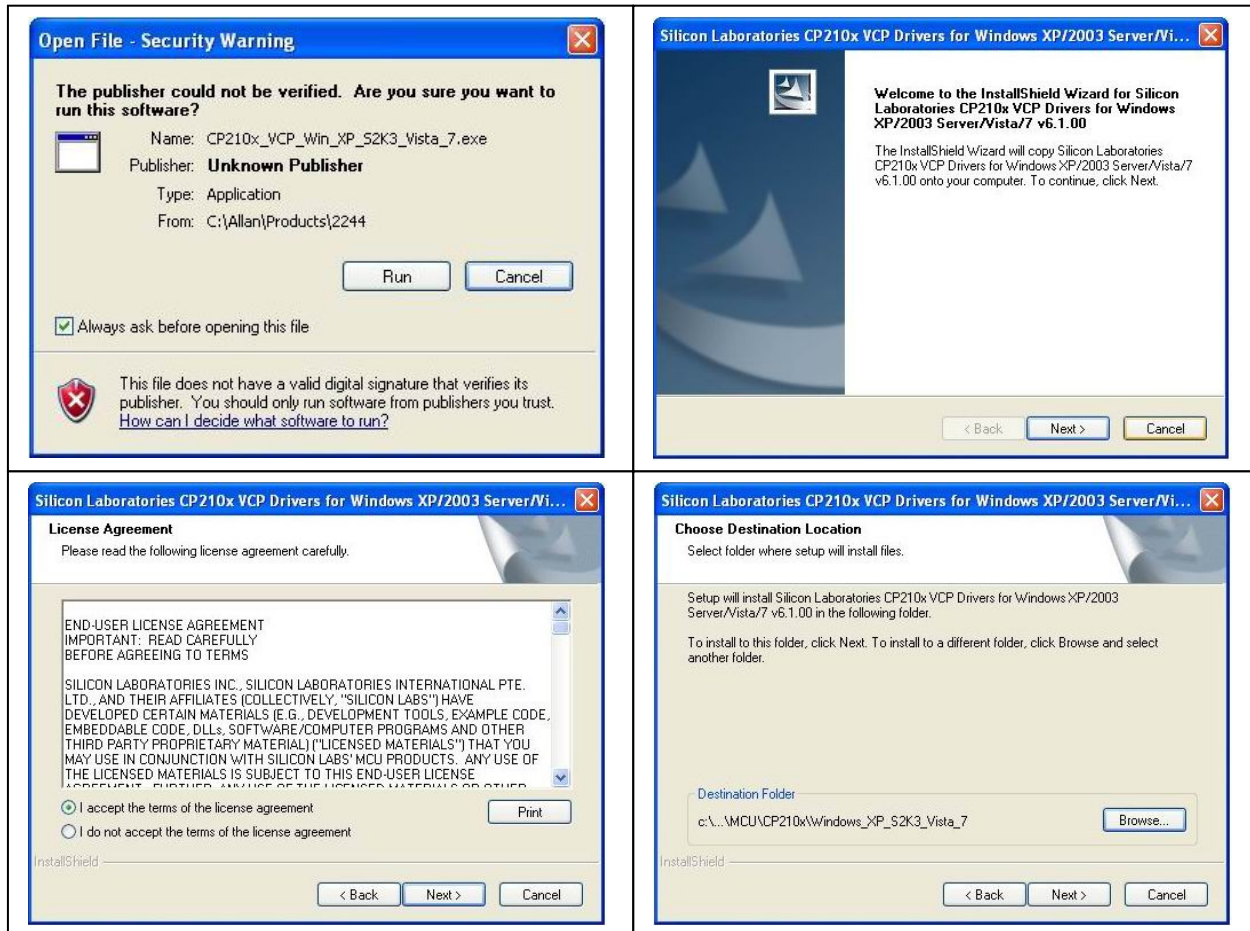

FIGURE 7: USB TYPE B CLI PORT

To operate and control the OSD2254P using the CLI an OSD2254P driver will be required to be installed onto the PC being used. The driver can be found on the included CD or on the OSD website. Please contact OSD sales if the driver cannot be found or installed. For Windows XP, Vista and Windows 7: CP210x_VCP_Win_XP_S2K3_Vista_7.exe. For Windows 2000: CP210x_VCP_Win2K.exe



OPTICAL SYSTEMS DESIGN

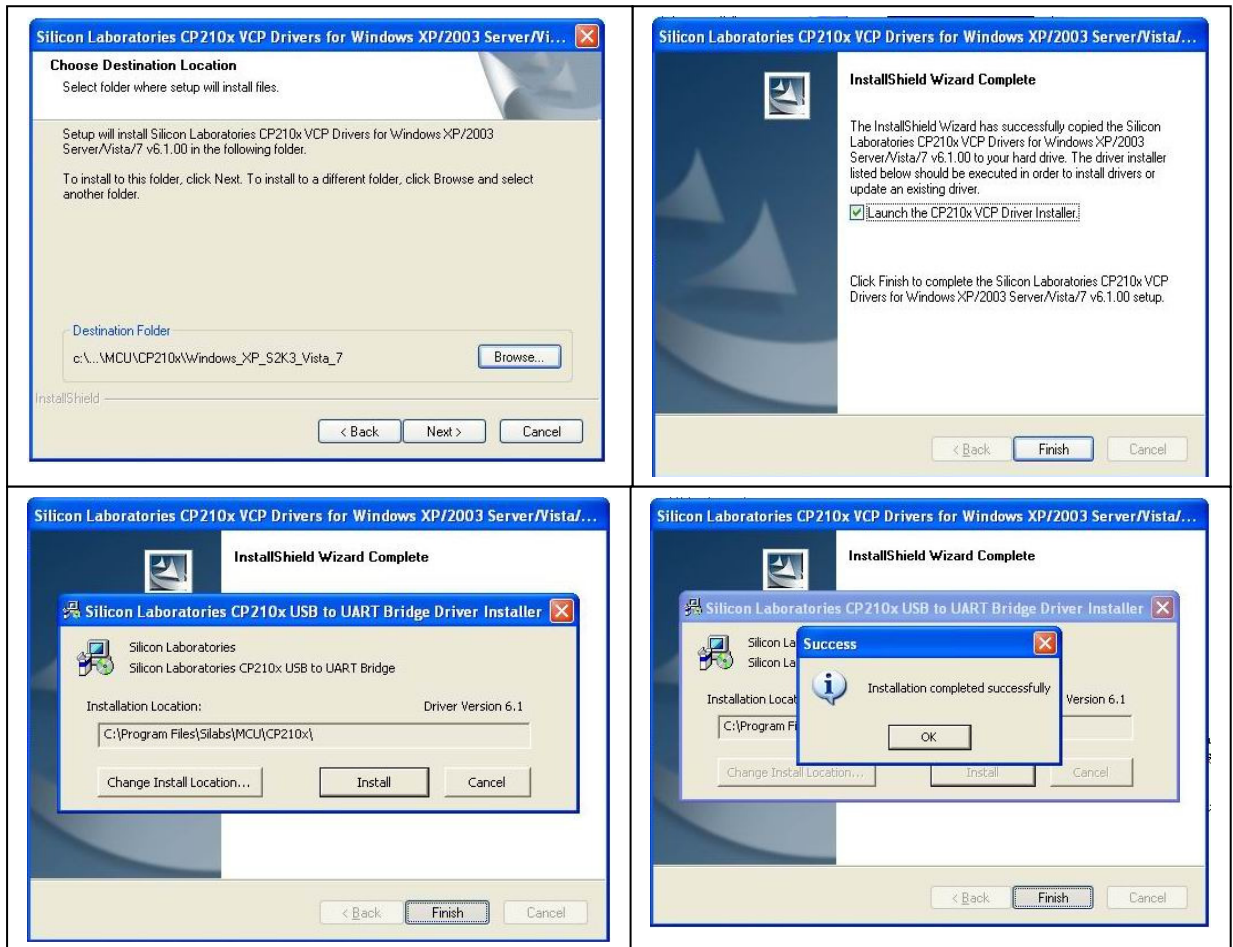

FIGURE 8: WIN XP INSTALLATION

OPTICAL SYSTEMS DESIGN

2.2.7 LED INDICATORS

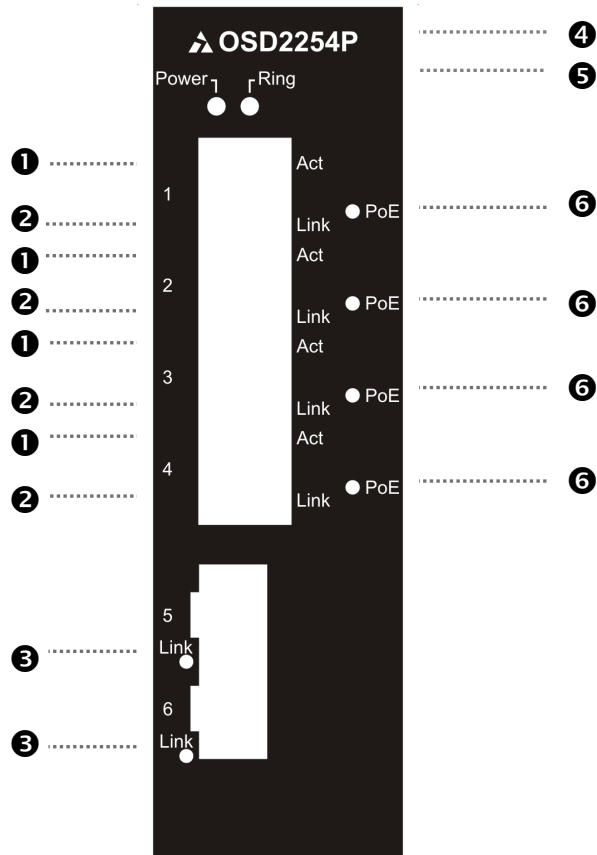

FIGURE 9: PORT/LED

TABLE 4: LED FUNCTION

| No | Function | | | LED Colour Function | | |
|----|-------------|----------|-------------|---------------------|-------|---------|
| | On | Blink | Off | Green | Gr/Am | Amber |
| ① | - | Activity | No Activity | 1Gbps | - | - |
| ② | Link | - | No Link | - | - | On |
| ③ | Link | Activity | No Link | 1Gbps | - | 100Mbps |
| ④ | Power | - | No Power | Power | - | - |
| ⑤ | Ring/Bus | Initial | - | Ring | - | Bus* |
| ⑥ | Load Detect | - | No Load | LD | - | - |

* Always Amber in non-ring mode

OPTICAL SYSTEMS DESIGN

2.2.8 CONTROLS

The OSD2254P has an 8-way DIP switch to control a number of functions. Table 5 outlines the function of each switch.

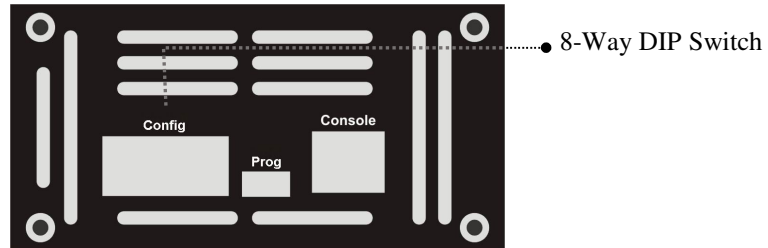

FIGURE 10: OSD2254P CONTROLS

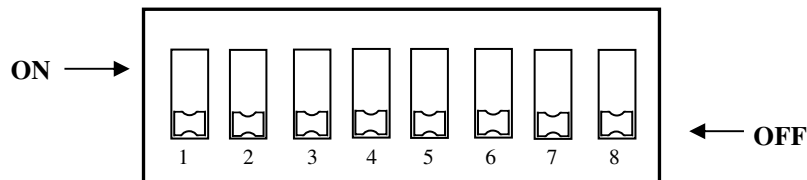

FIGURE 11: OSD2254P 8-WAY DIP SWITCH

TABLE 5: OSD2254P 8-WAY DIP SWITCH SETTINGS

| SWITCH NUMBER | DESCRIPTION | FUNCTION | SWITCH POSITION |
|---------------|--------------------|---|-----------------|
| 1 | Current Limiting | See Table 6 for Current Limiting function | OFF* |
| 2 | Current Limiting | See Table 6 for Current Limiting function | OFF* |
| 3 | Not Used | - | OFF* |
| 4 | Not Used | - | OFF* ON |
| 5 | Ring/Bus | Ring Non-Ring | OFF* ON |
| 6 | Port 5 Fiber Speed | 1000Mbps 100Mbps | OFF* ON |
| 7 | Port 6 Fiber Speed | 1000Mbps 100Mbps | OFF* ON |
| 8 | Programming Mode | Normal Operation Programming Mode | OFF* ON |

* Default settings.

† PD dependant

Note: The unit requires a power cycle (Off/On) for any switch position change to take effect.

OPTICAL SYSTEMS DESIGN

TABLE 6: CURRENT LIMITING SWITCH SETTINGS

| CURRENT LIMIT | SW1 | SW2 |
|-------------------------------|-----|-----|
| Manual Current Limit Disabled | OFF | OFF |
| 425mA | OFF | ON |
| 850mA | ON | OFF |
| 1275mA (60W) | ON | ON |
| 1750mA (90W) | ON | ON |

Some PD devices are non-standard and require current limiting to function and not damage equipment. It is advised to check PD device current requirements and set the current limits according to Table 6.

2.2.9 FITTING SFP CONNECTORS

Care should be taken when inserting/removing the SFP connectors from SFP port 3 and 4 as SFP modules are Electrostatic (ES) sensitive and Electrostatic Discharge (ESD) precautions should be taken when installing. Ensure that the SFP is fully engaged and latched into position.

Inserting SFP – Ensure that the SFP lever is in the locked position and insert into appropriate SFP port. Gently push the SFP until it locks into place. Remove plastic/rubber dust cap and fit fiber cable or RJ45 plug.

Removing SFP – Remove fiber connector or RJ45 plug. Pull the SFP lever down to unlock SFP from housing. Using the lever, gently pull the SFP out.

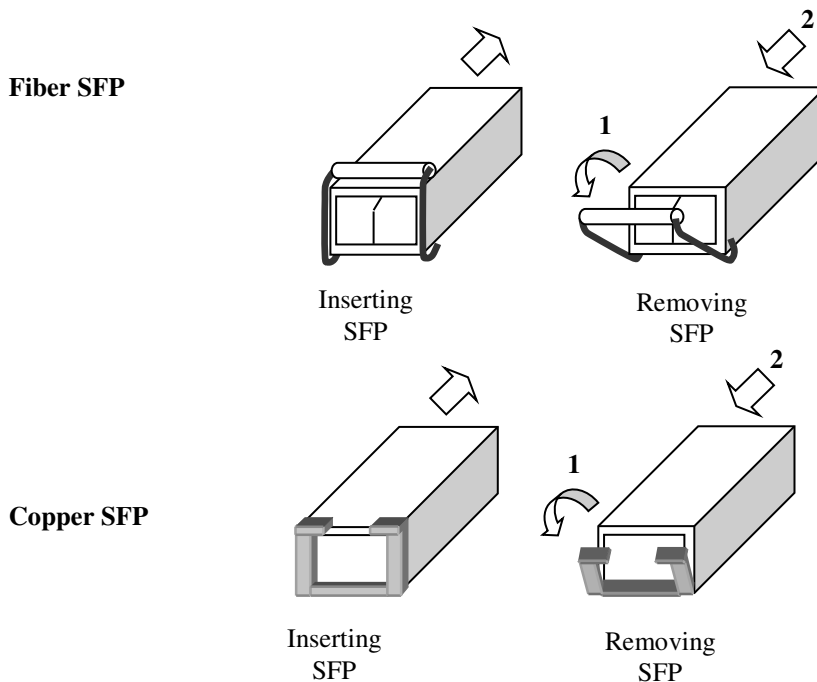

FIGURE 12: FITTING/REMOVING SFP CONNECTORS

OPTICAL SYSTEMS DESIGN

2.3 OSD2254P OPERATION

When using the OSD2254P for the first time, check that the unit is in good condition with no visible damage.

Upon power up check that the indicators illuminate accordingly on power up (see Table 4).

2.3.1 CONNECTIONS

For RJ45 connection use Category 5 (CAT5) or higher. Length should be no more than 100 meters.

For singlemode fiber connections, fiber used must be 9/125 μ m singlemode fiber.

For multimode fiber connections, fiber used must be 50/125 μ m or 62/125 μ m multimode fiber.

Plug in the appropriate connectors for system configuration;

- RJ45 cable to fixed copper ports (port 1 and 2) and copper SFP modules
- LC or SC fiber cable to fiber SFP modules.

Redundant Ring Operation

The OSD2254P connected in a redundant ring topology providing maximum reliability on critical networks. In the event of device or fiber failure the data path will automatically switch to a secondary path in less than 2ms per node to maintain ring network integrity.

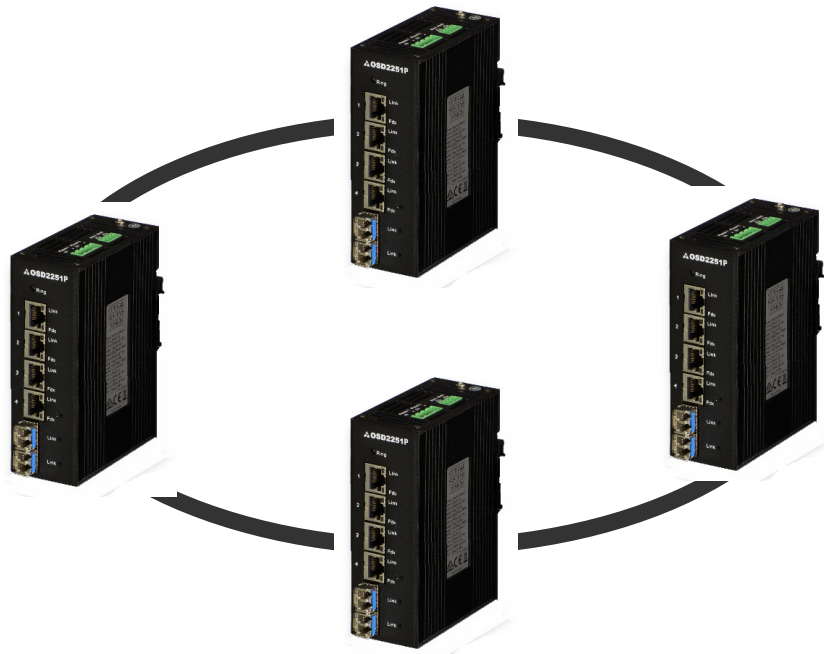

FIGURE 13: REDUNDANT RING CONFIGURATION

OPTICAL SYSTEMS DESIGN

To connect the OSD2254P in a redundant ring configuration ports 5 and 6 must be used together with fiber SFPs. The non-ring ports (ports 1,2,3,4) should be used to connect to your Ethernet devices (eg. Cameras, PLCs, computers, etc.)

Figure 14 shows the connection method. Typically the SFP used would be a fiber SFP with duplex LC connectors. The dashed line indicates the closed loop, but more OSD2254P units can be connected to the ring as required using this topology. Ensure that the switch settings for port 5 and 6 are set to 1000Mbps (1Gbps) – see Table 5.

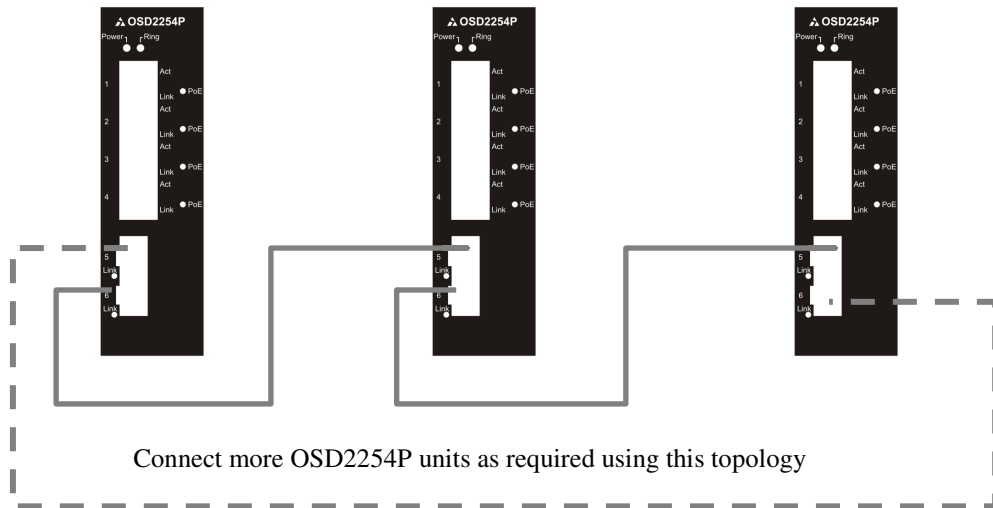

FIGURE 14: REDUNDANT RING CONNECTION

Bus Operation

To connect the OSD2254P in a bus configuration ports 5 and 6 must be used together with fiber SFPs. The remaining ports (ports 1,2,3,4) should be used to connect to your Ethernet devices (eg. Cameras, PLCs, computers, etc.)

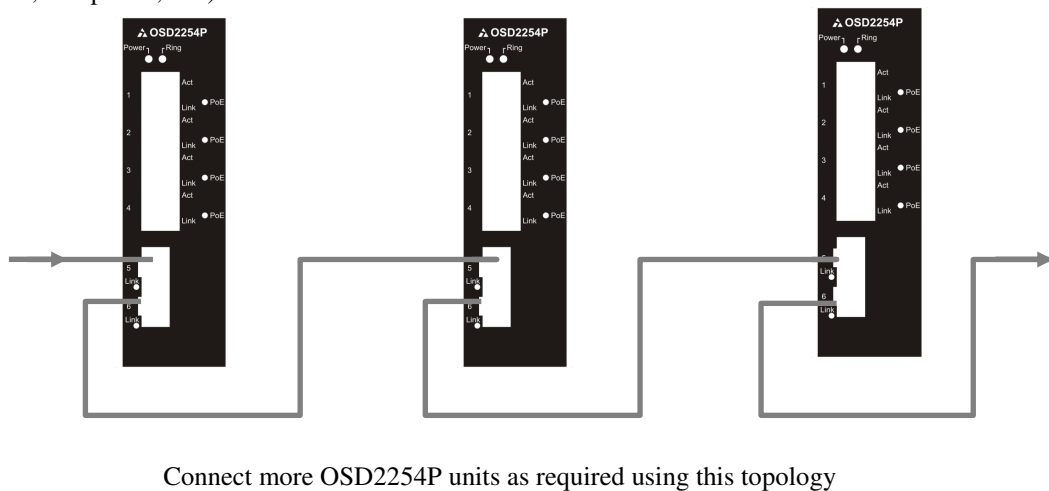

FIGURE 15: BUS CONNECTION

OPTICAL SYSTEMS DESIGN

2.4 TYPE-A USB PORT

The Micro USB Port is used for uploading firmware updates. All OSD2254P units will be shipped with the latest firmware already installed. This port has no function for end user.

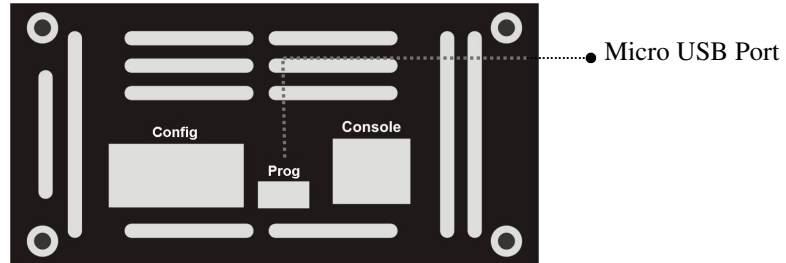

FIGURE 16: OSD2254P MICRO USB CONNECTOR

OPTICAL SYSTEMS DESIGN

2.5 COMMAND LINE INTERFACE

The Command Line Interface (CLI) is a useful tool for checking link status and debugging link connections. To enable the use of CLI the OSD2254P must be connected to a PC with a serial port and an appropriate cable as specified in section 2.2.6. Using a terminal emulation program such as Hyperterminal, a number of command lines specific to the OSD2254P can be implemented to check link/node status, ring/bus topology and enable/disable float backup.

2.5.1 TERMINAL EMULATION SETUP

Using a terminal emulation program such as hyperterminal the following parameters should be set up for correct command line operation. Select the appropriate “COM port” set up for the serial port.

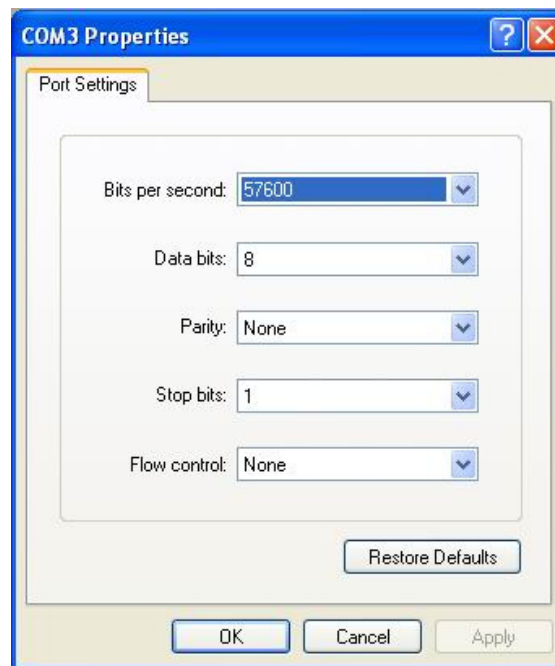

FIGURE 17: SERIAL PORT SETTINGS

OPTICAL SYSTEMS DESIGN

2.5.2 COMMAND LINE FUNCTIONS

There are a number of command line functions that enables the user to obtain running information of a single OSD2254P unit or the complete topology of the ring/bus network. This section explains the command lines and its functions.

When the terminal emulation program is operating, connect the USB cable to any one of the OSD2254P units on the ring/bus network – or alternatively, the OSD2254P unit which the user wishes to interrogate. Note: A message will be displayed on the terminal emulation program when the unit is powered after USB connection. This message will not open when the unit is switched on while plugging in the USB cable, however the command lines are functional.

The following table outlines the user available command line commands and their functions

TABLE 7: TERMINAL COMMAND LINES

| TERMINAL COMMAND LINE | SPECIFICATION | FUNCTION | FIGURE |
|-----------------------|------------------|--|-----------|
| tc | Topology Check | Displays the topology status of the established ring/bus | Figure 18 |
| lnc | Local Node Check | Gets running status of the local node | Figure 20 |
| vc | Version Check | Displays the current software version and revision installed on the unit | Figure 21 |

OPTICAL SYSTEMS DESIGN

TOPOLOGY CHECK - <tc> Command Line

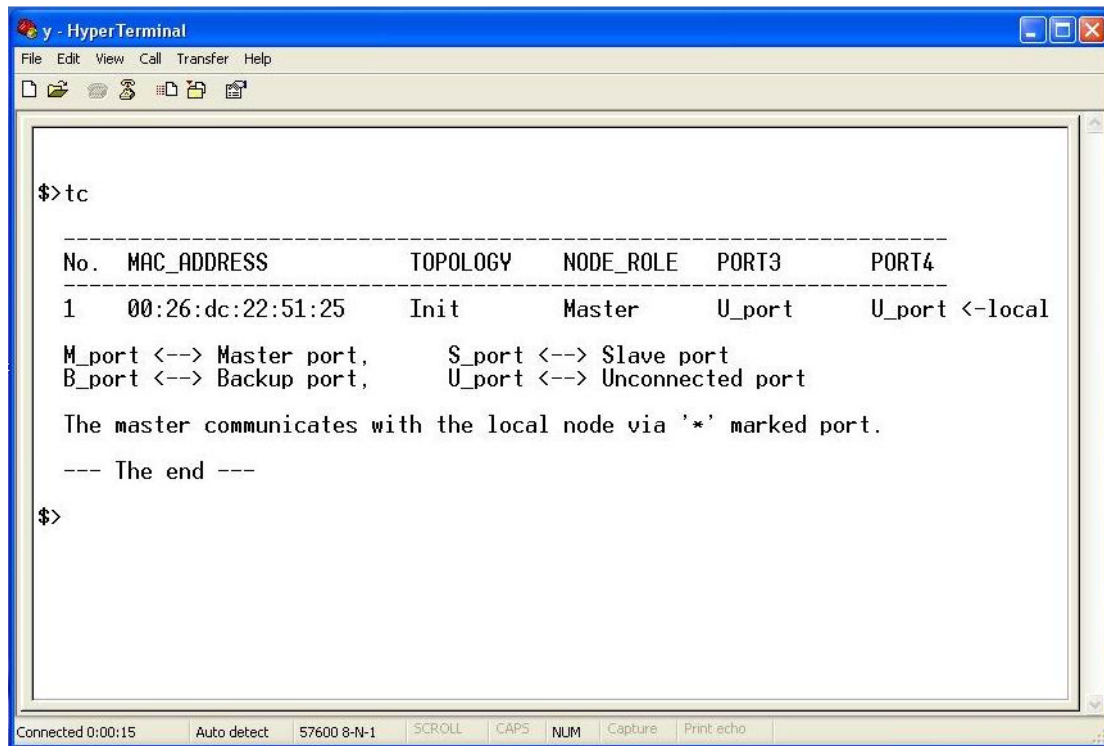

```
$>tc

-----
No.  MAC_ADDRESS      TOPOLOGY  NODE_ROLE  PORT3      PORT4
-----
1    00:26:dc:22:51:25  Init      Master     U_port     U_port <-local

M_port <--> Master port,      S_port <--> Slave port
B_port <--> Backup port,      U_port <--> Unconnected port

The master communicates with the local node via '*' marked port.

--- The end ---

$>
```

FIGURE 18: TOPOLOGY CHECK

In this case, only one OSD2254P is connected to the USB cable. The display indicates the following:

No: 1 – Number of units connected on the ring/bus (in this case only one unit)

MAC_ADDRESS: 00:26:dc:22:51:25 – Displays all the MAC addresses of the units connected on the ring/bus

TOPOLOGY: Init – Displaying type of connection (in this case “Init” as there is only one unit)

NODE_ROLE: MASTER – Displays whether the unit is either the Master or Slave on the ring/bus (in this case only one unit is connected thus displaying master). The Master unit is determined by the unit with the lowest MAC address

PORT3: U_port. Indicates the function of port 3 and its relation to the ring/bus. There are four possibilities;

1. M_port – Master Port (port facing the master)
2. S_port – Slave Port (port back to the master)
3. B_Port – Backup Port
4. U_Port – Unconnected Port

PORT4: U_port. Indicates the function of port 4 and its relation to the ring/bus. There are four possibilities;

1. M_port – Master Port
2. S_port – Slave Port
3. B_Port – Backup Port
4. U_Port – Unconnected Port

<-local: This points to the unit that the USB cable is plugged into on the ring/bus.

OPTICAL SYSTEMS DESIGN

In the example below there are four OSD2254P connected in a ring configuration.

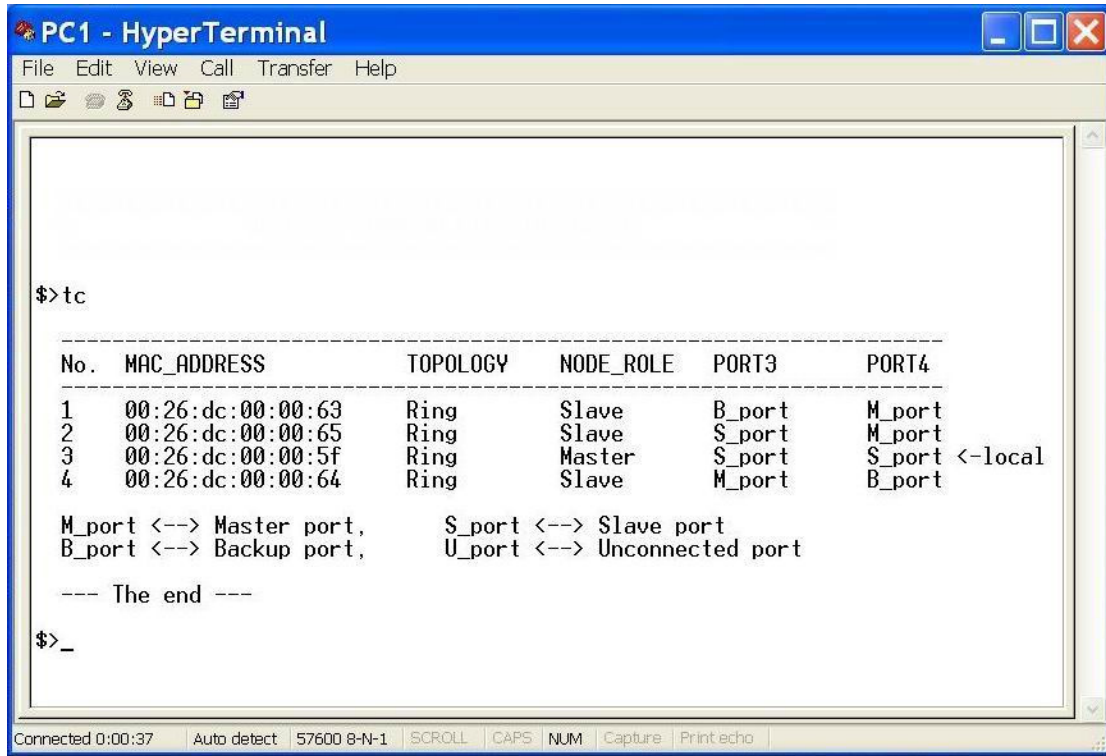

FIGURE 19: TOPOLOGY CHECK

No: 4 – Four units connected

MAC_ADDRESS:– Displaying all the MAC addresses of the units connected on the ring/bus

TOPOLOGY: Ring – Displaying type of connection.

NODE_ROLE: MASTER – Displays if the unit is either the Master or Slave on the ring/bus. Master is determined by the lowest MAC address

PORT3: U_port. Indicates the function of port 3 and its relation to the ring/bus. There are four possibilities;

1. M_port – Master Port
2. S_port – Slave Port
3. B_Port – Backup Port
4. U_Port – Unconnected Port

PORT4: U_port. Indicates the function of port 4 and its relation to the ring/bus. There are four possibilities;

1. M_port – Master Port
2. S_port – Slave Port
3. B_Port – Backup Port
4. U_Port – Unconnected Port

<-local: This points to the unit that the USB cable is plugged into on the ring/bus.

OPTICAL SYSTEMS DESIGN

LOCAL NODE CHECK - <inc> Command Line

```
h - HyperTerminal
File Edit View Call Transfer Help
$>inc
-----
Information of LOCAL node with MAC address: 00:26:dc:22:51:25
-----
1  TOPOLOGY:           Init
2  NODE_ROLE:         Master
3  PORT_ROLE(port3):  Unconnected_port(U_port)
4  PORT_ROLE(port4):  Unconnected_port(U_port)
5  Float Backup Function: Enabled
--- The end ---
$>_
Connected 0:07:26  Auto detect  57600 8-N-1  SCROLL  CAPS  NUM  Capture  Print echo
```

FIGURE 20: LOCAL NODE CHECK

This command line displays the running status of the local node that the USB cable is plugged into. The information provided is the MAC address, Topology, Node Role, Port Role and Float Backup status.

OPTICAL SYSTEMS DESIGN

VERSION CHECK - <vc> Command Line

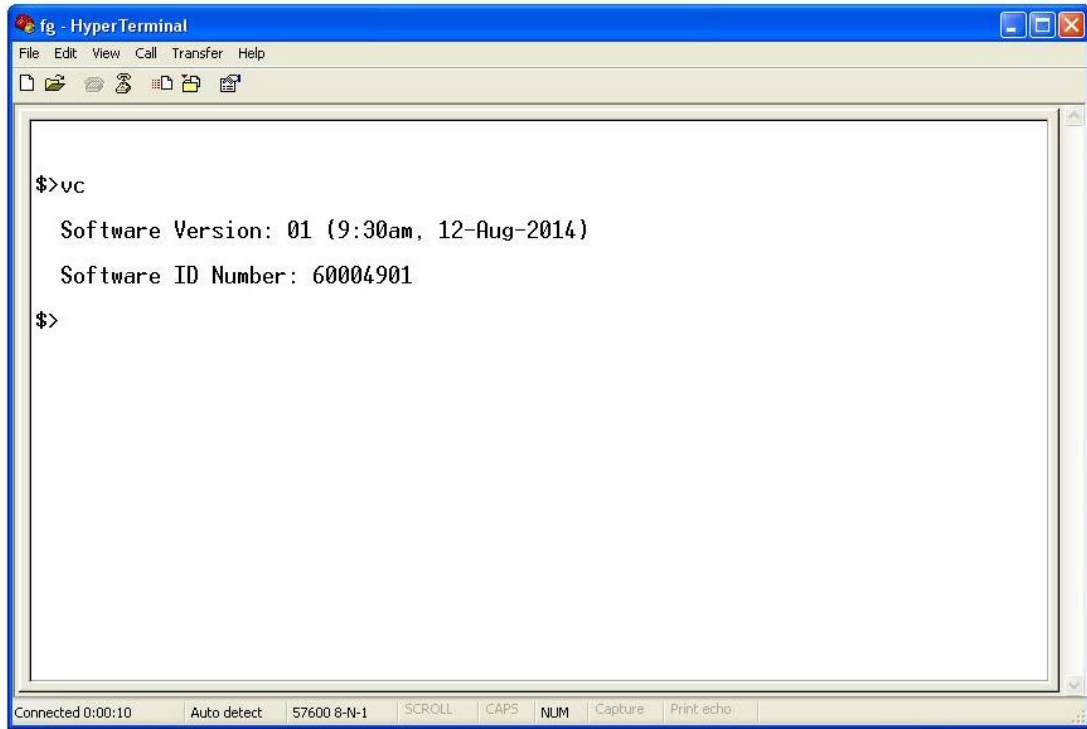

```
fg - HyperTerminal
File Edit View Call Transfer Help
$>vc
Software Version: 01 (9:30am, 12-Aug-2014)
Software ID Number: 60004901
$>
```

FIGURE 21: VERSION CHECK

Displays the Software Version Number and Software ID Number installed on the OSD2254P

3 MAINTENANCE

3.1 INTRODUCTION

The following section outlines the fault-finding procedure for the OSD2254P modems. Please take note of the following:

- ▲ Personnel without appropriate training should not attempt any maintenance except that outlined below.
- ▲ If further maintenance is attempted you are warned that every care should be taken to ensure that internal measurements made while the equipment is operational are taken carefully as some components within the unit are expensive and may be damaged by failure of any portion of their support circuitry.
- ▲ Some components within the unit are Electrostatic (ES) sensitive and Electrostatic Discharge (ESD) precautions should be taken when performing maintenance upon the unit.

3.2 EXTERNAL INSPECTION

Visually check for the following:

- ▲ Check that the correct power source is connected to the power socket.
- ▲ Check that the Ethernet cables are connected to the modem correctly and that the distant OSD2254P modem has been connected correctly to any external equipment.
- ▲ Inspect the optical connectors (for fiber SFP option) for any contamination and clean using isopropyl alcohol and a lint free tissue if any contamination is detected.

3.3 ROUTINE MAINTENANCE

- ▲ There is no routine maintenance required with the OSD2254P.

4 WARRANTY

Thank you for purchasing equipment designed, manufactured and serviced by Optical Systems Design (OSD). OSD warrants that at the time of shipment, its products are free from defects in material and workmanship and conforms to specifications. Our Warranty conditions are outlined below:

4.1 WARRANTY PERIOD

For warranty period, please contact your local OSD distributor.

4.2 REPAIRS

Optical Systems Design reserves the right to repair or replace faulty modules/units. Please obtain a "Return Material Authorisation" (RMA) form and number before returning goods.

Goods must be returned in adequate packing material to Optical Systems Design, Warriewood or its nominated authorised representative, for all repairs.

4.2.1 WARRANTY REPAIRS

Return shipments to OSD shall be at customer's expense and freight back to the customer will be at OSD expense.

4.2.2 OUT-OF-WARRANTY REPAIRS

OSD reserves the right to repair or replace any faulty goods. Freight costs and insurance for both journeys are met by the user. All equipment repaired by OSD will have a 3-Month Warranty from the date of dispatch.

4.2.3 SITE REPAIRS

By agreement site repairs may be undertaken for which out of pocket, hotel and travel expenses will be charged.

4.2.4 EXCLUSIONS

This warranty does not apply to defects caused by unauthorized modifications, misuse, abuse or transport damage to the equipment. All modifications to OSD's standard product will need written authorization and will be charged at normal repair rates. All modifications are to be carried out by OSD Technicians. Warranty is void if unauthorized removal and/or tampering with serial number and/or repair labels is evident.

OPTICAL SYSTEMS DESIGN

Optical Systems Design Pty. Ltd.

7/1 Vuko Pl. Warriewood 2102

P.O. Box 891 Mona Vale

N.S.W. Australia 2103

Telephone: +61 2 9913 8540

Facsimile: +61 2 9913 8735

Email: sales@osd.com.au

Web Site: www.osd.com.au

OPTICAL

SYSTEMS

DESIGN

PTY LTD

A.B.N. 83 003 020 504

Printed in Australia